

SP
751
W3

UC-NRLF



B 3 109 016



The
FIRST AID
FARM VETERINARIAN
for

CATTLE, SWINE, SHEEP, HORSES

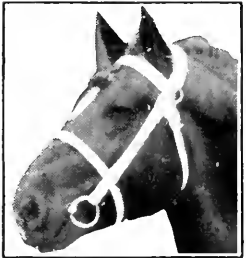

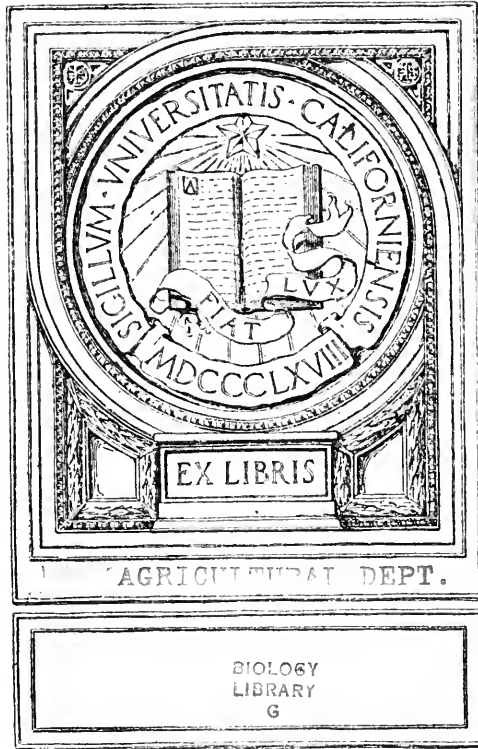

Digitized by the Internet Archive
in 2008 with funding from
Microsoft Corporation

The First Aid Farm Veterinarian

A COLLECTION OF
AUTHORITATIVE SUGGESTIONS
ON THE CARE OF

Cattle, Swine Sheep, Horses

COMBINED WITH A CHOICE SELECTION OF ILLUSTRATIONS
OF PRIZE WINNING AND FAMOUS TYPES OF LIVE STOCK

By

S. H. WARD, V. S.

Secretary and Executive Officer

Minnesota Live Stock Sanitary Board

Secretary-Treasurer

United States Live Stock Sanitary Association

This collection of suggestions is prepared, as the title states, as a "First Aid Farm Veterinarian." It does not attempt to prescribe for the cure of ills peculiar to live stock, as it is always safer to entrust this to the local Veterinarian or expert.

Rather, it deals with helpful suggestions for emergencies and is to aid the Farmer in the timely recognition of ailments of live stock. Valuable charts and illustrations of educational and practical use are also shown.

Copyright by Brown & Bigelow

St. Paul, Minn., and Chicago, Ill.

BIOLOGY
LIBRARY
G

TABLE OF CONTENTS



70 Interesting Illustrations of Famous Types of Live Stock.			
1 Full Colored Centerpiece—Anatomical Charts of Live Stock—Cattle, Horses, Swine and Sheep.			
	<i>Page</i>		<i>Page</i>
1 Diagram—Cows' Teeth according to Age...	11	1 Diagram—How to Tell the Age of a Horse...	31
1 Breeding Table for Live Stock.....	21	1 Chart—Regions of the Horse.....	32
1 Breeding Record for Cows.....	22	1 Diagram—Self Feeder for Pigs.....	39
1 Breeding Record for Mares.....	23	1 Diagram—Sheep's Teeth According to Age..	44
1 Breeding Record for Sows.....	26	1 Diagram—A Closed Sheep Shed.....	45
1 Breeding Record for Ewes.....	27		

FIRST AID SUGGESTIONS FOR LIVE STOCK

	<i>Page</i>		<i>Page</i>
Care of Live Stock.....	3	Lung Diseases.....	19
Nursing Sick Animals.....	3	Kidneys.....	19
Administration of Medicines.....	4	Blood Circulation.....	19
CATTLE			
Popular Errors.....	4	Nervous Diseases.....	20
Traumatic Pericarditis.....	5	Parasites.....	28
Phlebitis.....	5	Sunstroke.....	28
Pleurisy.....	6	Cerebro Spinal Meningitis.....	29
Verminous Bronchitis.....	6	Skin Diseases.....	29
Excessive Salivation.....	6	Bleeding Warts.....	29
Choke.....	6	Contagious Diseases.....	30
Lumpy Jaw.....	7	Navel or Joint Ill.....	30
Bloating.....	7	Lock Jaw.....	30
Impaction.....	7	Distemper.....	33
Diarrhoea.....	7	Influenza.....	33
White Scours.....	7	SWINE	
Stone in the Urethra.....	8	Sore Mouth.....	34
Rancid Milk.....	9	Vomiting.....	34
Rupture.....	9	Air Bubbles in Intestines.....	34
Wounds of the Abdomen.....	9	Thumps.....	34
Paralysis of the Hind Quarters.....	9	Rheumatism.....	34
Eye Inflammation.....	10	Rickets.....	34
Tuberculosis and Symptoms.....	10	Heat Stroke.....	34
Warts.....	12	Verminous Bronchitis.....	35
Ergotism.....	13	Hog Cholera.....	36
Sorghum Poisoning.....	13	Neerobacillosis.....	38
Cow Pox.....	13	Tuberculosis.....	38
Rabies.....	14	Parasites.....	40
Contagious Abortion.....	15	Fits.....	41
HORSES			
Fracture of Bones.....	16	Hemorrhoids, Piles.....	41
Wounds.....	16	Lice.....	41
Nail Punctures of Feet.....	16	SHEEP	
Founder.....	17	Hemorrhagic Septicaemia.....	42
Digestive Troubles (Teeth - Tongue).....	18	Parasites.....	43
Colic.....	18	Verminous Bronchitis.....	43
Poisoning.....	19	Grub in the Head.....	44
		Foot Rot.....	44
		Scab.....	46

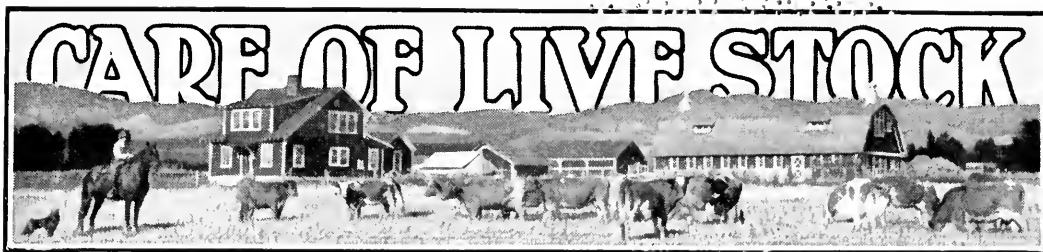

NO attempt will be made to present the symptoms or treatment of all the various diseases which live stock are subject to.

It may be said that the anatomy of the farm animal is essentially the same as the human being, the various parts and vital organs of all animals and man perform the same functions. While there is a difference in their size, the heart of the horse, cow, sheep or pig must be, as in man, the central pumping machine; so the kidneys in the domestic animal must, as in man, act as the draining system for the excess fluid of the body. Keeping in mind this similarity to the body of man, we can, to a great extent, prevent many of the common troubles by exercising the same care with the farm animals as we do in guarding our own health.

It is important to keep in mind "kindness of heart" often causes more intestinal trouble in horses than any other cause. For instance, owners frequently having in mind a hard day's work for the team, reason an extra feed of grain will lend strength for the coming exertion. They do not think that were the positions reversed, the man would not eat an extra amount and expect to begin a hard day's labor on an engorged stomach. Nor does a man after a long fast and exhausting work fill his stomach with cold water; rather he drinks small quantities at a time. The owner does not think what he would do under the circumstances, but proceeds to give the animal all it desires.

Again, it is the common practice among farmers to keep hay before their animals at all times.

Go into the majority of the barns and we find the mangers crowded with hay and the stalls more or less littered with it. Animals so fed rarely keep in condition and are never able to perform the amount of work they are capable of. For the average 1500-lb. farm horse 20 lbs. of hay a day is sufficient and when in hard work the grain ration can be increased, and reduced when not working. Where a good feeder is in charge of a barn we find the mangers are cleaned up of all feed. Again a careful owner sees that his horses are given a laxative feed at least once a week. Sudden changes of diet for any animal must be avoided; horses fresh from grass must be gradually brought on to dry feed, and when animals are turned out care should be taken not to put them in pastures which have an abundant growth. This rule applies to all domestic animals.

Live stock should not be fed entirely on coarse woody material, such as straw, corn stalks or hay, put up late in the season. Their rations should be changed occasionally to a more laxative diet. Dry feed taxes the digestive powers and if persisted in brings on a variety of bowel troubles.

NURSING SICK ANIMALS

As the work of caring for sick animals falls upon the owner, a few fundamental principles may be laid down for his guidance. Again, the owner is to be reminded of conditions were he the patient. As a rule he may simply think of what would add to his comfort, and by applying them to the patient feel assured he is carrying out the proper method.



RANGE CATTLE

392572

If possible the patient should be placed in a box stall, away from annoyances of other animals. The quarters should be well ventilated and kept clean. The attention required includes feeding, watering, and the giving of medicine. Water and feed should not be allowed to stand, and a fresh supply should be constantly given. In the hot weather fresh, cold water should be given at frequent intervals, as it tends to reduce fever and refreshes the patient. The fact that animal does not eat should not alarm the owner; when recovery begins the appetite returns, and it is then that careful feeding is required. The same general principles should be applied to all farm animals.

ADMINISTRATION OF MEDICINES

Unless medicine can be given in the feed, it is very unwise for owners to attempt to force any animal to swallow liquids. Even when great care is exercised by veterinarians, some of the liquid may pass into the wind pipe to the lungs, setting up a severe form of pneumonia.

Bottles and receptacles in which medicine is to be placed should first be thoroughly cleaned.

POPULAR ERRORS IN REGARD TO DISEASE

Lampas, seen in young horses is a simple congestion of the hard palate behind the upper front teeth, and is associated with the eruption of the permanent teeth. Many owners seem to think the condition is one that requires some treatment, but as a matter of fact no interference is required.

Hollow Horn, popular fallacy that remains from olden days, and treated by boring a hole in the cow's horn and then pouring in turpentine, which is supposed to solidify the horn. As a matter of fact the horn is hollow and any treatment of that nature is inhuman.

Wolf Tail—Tail Ill, in which the animal is supposed to have a worm in the end of the tail. The ignorant quack proceeds to split the end of the tail and fill the wound with a mixture of pepper and salt.

Black Tooth in Pigs. This condition is another myth, which still exists in the minds of the ignorant, and is supposed to cause the death of young pigs.

The above delusions are mentioned so that owners may not lose time in treating imaginary disease, when the real trouble should be looked for elsewhere.



HERD OF SHORTHORN STEERS

SHORTHORNS originated in England and are the most popular beef bred in the world. They attain the largest size of any types of beef cattle. Cows weigh about 1500 lbs.; bulls 2200 lbs.; finished steers 1200 to 1500 lbs. They do not mature so early as some of the other types of beef cattle. Colors are red, white and roan.



FOREWORD

IT is the intention of the writer to direct attention only to certain conditions in cattle, which to a very large extent may be obviated by proper care and attention on the part of the owner. To give an outline of all the diseases which cattle are affected with, would defeat the object intended. Nor would the reader benefit for the reason that even with the experienced, trained veterinarian diagnosis is often difficult. To wait until the classical symptoms appear would in many cases be too late.

It is proposed, therefore, to confine the subject to matter that the cattle owner should be familiar with.

Traumatic Pericarditis. An inflammation of the heart sac caused by an injury, due in almost every case to a nail, wire or some penetrating sharp substance which has been swallowed by the cow. The manifestations of this condition are observed or suspected only by an expert veterinarian. As a rule the disease is frequently mistaken for tuberculosis, due to the fact that animals so affected exhibit a shortness of breath, more or less fever, and are not apt to keep in condition. Sudden death of the animal may cause the owner from curiosity to make a post mortem, and it may be with some surprise he finds the heart sac quite large, containing a great deal of foul smelling fluid mixed with pus, and a closer examination reveals a spike, piece of wire or other sharp object penetrating through the wall of the stomach and midriff into the heart sac.

The object of drawing the reader's attention to this accidental trouble is for the purpose of impressing upon him the necessity of keeping his barn yard clean of all objects not intended for food purposes.

Owners have no doubt observed in the Spring of the year a propensity for cattle to chew foreign objects such as bones, cloth, rope, and wood. Such foreign material when swallowed may cause the death of animals, hence due care should be exercised.



TYPICAL REGISTERED HOLSTEIN HEAD

Phlebitis. Inflammation of the jugular vein. This is occasionally seen in young bulls and is caused by a hook while fighting and may be recognized by a swelling extending from perhaps half way down the neck to the brisket in the region of the windpipe.

A blow or hook may partially or completely rupture the wall of the blood vessel, permitting the escape into the tissues of a very large amount of blood. No attempt should be made by the inexperienced to open any swellings in the region of the throat or windpipe. Large blood vessels traverse this region and there is grave danger of injuring them.



REGISTERED HOLSTEIN HERD—FOX RIVER VALLEY, ILL.

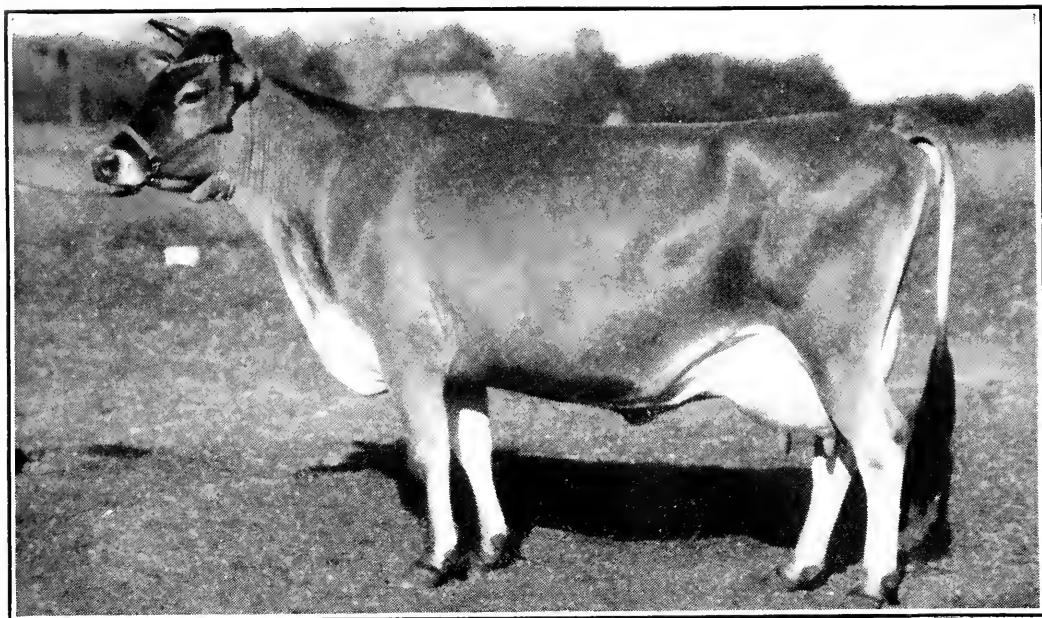

"GLORIA BENEDICTINE." A world famous champion Jersey Cow: an excellent example of what has been accomplished by improved breeding, feeding and careful management.

The Jersey breed originated in the Island of Jersey in the Channel Islands near England. The quality and richness of milk is unequalled. Jerseys are often called "the butter cow." They are very popular in the United States. Weight 700 pounds upward. Color, many shades of fawn, reddish, silver, brownish, etc.

Pleurisy is the most common lung trouble in cattle.

Causes are sudden cooling of the body, as lying on damp ground or from sudden chilling of the side of an animal by the opening of the stable door, permitting the entrance of cold air. It is noticed by the stiff gait and peculiar grunt emitted when animal is made to move. The elbows are noticed to be turned out and appetite fails. Mustard plasters to the side should be immediately applied and proper treatment given as soon as available. While not dangerous, we occasionally find a large amount of water will accumulate in the chest cavity, which sometimes becomes so great as to force its way out of the chest alongside of the windpipe, causing more or less swelling of the brisket. In other cases neglect of proper treatment results in the lung itself growing to the wall of the chest, causing more or less constant pain, which is not conducive to the thriftiness of the animal.

Vermineous Bronchitis, or worms, in the lung. This condition is quite frequent in young calves and will be described under parasites of sheep, as we have a similar condition in calves, pigs, and sheep; in fact in every animal which chews its cud.

DIGESTIVE ORGANS

Excessive Salivation. Sometimes seen in horses as a result of being fed on clover. This condition does not follow such when fed to cattle. It occurs in cattle from probably three or four causes: rabies (which see page 14), inflammation of the lining of the mouth from some irritant and oftener as a result of a foreign body, such as a piece of wood, corn cob, or other object becoming lodged in the mouth, or from choking. In the latter case animal bloats very quickly. An examination of the mouth is advisable, but if rabies is prevalent no attempt at examination should be made.

Choke: See under horses, page 19.



HERD OF PURE BRED JERSEYS

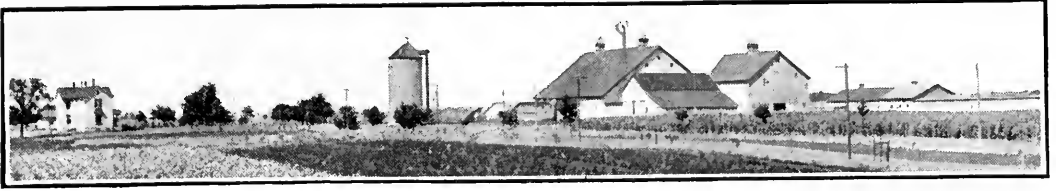

A PROSPEROUS FARM

Lumpy Jaw. This condition is easily recognized by the swelling which extends out from the lower jaw bone.

Prompt, expert treatment should be given, otherwise if neglected the swelling becomes quite large and finally breaks; as a result the value of the animal deteriorates.

Bloating is often encountered following heavy feeding. The ordinary washing soda (hypo-sulphite of soda) used by photographers is very useful when given in tablespoonful doses in the feed. If bloating persists other causes should be looked for. Animals bloat on pasture as a result of a too abundant vegetation. When this condition exists in pastures, cattle should be allowed to remain therein but a short time. Wet, luxurious pastures are very prone to cause bloat.

Impaction of the rumen or large stomach is not very common, but occurs when cattle break into any green crop and gorge themselves. When this happens animals should be kept from water. It may happen that an operation will be necessary by cutting into the large stomach and removing the larger part of its contents.

Diarrhoea. Frequently seen in young calves and is described under "White Scours." In old cattle unless the trouble continues little or no attention need be paid it. Small doses of diluted hydrochloric

acid in drinking water relieves the trouble.

White Scours in Calves. This disease appears in young calves ranging from a week to a month in age and has a very high mortality and is very similar to navel ill in colts. About the first symptom noticed is the refusal of the calf to nurse, and shows an inclination to remain lying down. A profuse yellowish, foamy diarrhoea is noticed and in a short time animal becomes extremely weak and emaciated.

The organism which causes the disease is taken up in some way by the calf, just how has so far not been definitely determined. It is known the feces of affected calves remain virulent for considerable time, hence when the disease appears in one calf it is very likely to spread to others.

Preventive treatment consists in keeping the stables clean and disinfected. Affected calves should be immediately isolated, and manure and litter removed and burned. Floors and entire stall should be disinfected as suggested elsewhere.

Vaccination of infected animals is recommended and the strength sustained by careful feeding. This disease like many others is in part due to dark, dirty pens.

Germes of all descriptions do not thrive in sunlight, but find their best growth in dark, damp places, where they retain their vitality for a long period of time.



AYRSHIRES—PRIZE BULL AND COW

The Ayrshire type of dairy cattle originated in Scotland. The average weight of cows about 1000 lbs., the bulls 1500 lbs. The colors include white, brown and red. Ayrshires are neat in appearance. Noted for cheese making qualities.

Stone or Calculus in the Urethra. Bulls and feeding steers frequently suffer from retention of urine as a result of small stones which are arrested in the urethra in their passage from the bladder. This malady is more generally seen in the winter months. It often occurs in feeding steers, especially those fed heavily on corn. These stones or calculi are of lime formation, and may be quite small, resembling gritty particles, or on the other hand may be quite large.

or less restlessness, indicating pain and anxiety. It will probably be seen the floor is dry, indicating no urine has been passed. We are told to follow the course of the urethra and at the double curve mentioned the calculus can be felt. Such is not the case, the tissues are too dense and deeply situated to enable one to locate the obstruction.

It is necessary to employ expert assistance in such cases. In a great many cases



"CLIVE IRIS" AND "MAJESTIC LADY," Prize Winners, Bred by E. H. Taylor, Jr., Frankfort, Ky.

HEREFORD beef cattle, sometimes called "White Faces," originated in Hereford County, England. They are a close second to the Shorthorn cattle for size while they lack the full quarters of the Shorthorn. Herefords possess early maturing qualities and are good grazers. The colors are red with white markings.

Similar conditions are found in wethers, where the sheep have access to corn fields.

The peculiar anatomy of the canal in steers, forming as it does a double curve on itself, acts as an obstacle for passage of foreign bodies. The result is a blocking of the passage, which unless relieved will cause death either through the rupture of the bladder or uremic poisoning.

Symptoms are somewhat veiled, and may escape the most observing. We notice more

it has been found to be wise to immediately beef the animal rather than to go to the expense of operating and assume burden of the necessary after care.

Animals that are given the run of the feed lot as well as the herd bull should be carefully watched and should receive a certain amount of suitable roots and not be subjected to the continuance of the usual dry feed without change or occasional deviation.

Milk. Several conditions affecting milk are very often a matter of worry to the owners of cattle and brief mention of these will be made.

Viscid Milk. Where this is found when milking the condition may be due to constitutional troubles. Hyposulphite of soda in tablespoonful doses three times a day may correct the trouble. When it occurs in milk which has stood for some time, it is due to contamination after being drawn from the cow. Bitter, red, yellow and blue milk are all due to certain organisms which enter the milk from outside sources.

Milk is easily affected and also absorbs strong odors and gases, consequently great care should be taken to keep cow sheds clean and sanitary at all times.

Rupture, or Hernia is of frequent occurrence and in all cases produced from blows, kicks, or hooks. As a rule, little can be done.

In umbilical or navel hernia, some portion of the intestines may drop into this aperture through which the blood vessels pass from the mother to the fetus. It may happen to new-born calves, or some time later. Unless the rupture is exceedingly large no anxiety need be felt as in many cases the animal will outgrow this trouble.



SHORTHORN

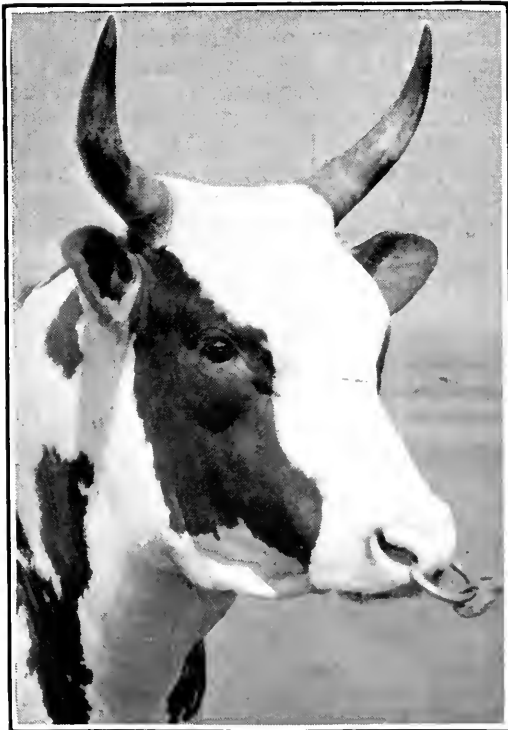

AYRSHIRE

Wounds of the Abdomen, caused by the horns of other animals may permit the escape of the intestines. When it occurs parts should be washed with clean, warm water to which a little salt can be added, just enough so that one may barely taste it. After thorough washing, bowels could be returned and a makeshift bandage applied, pending expert help.

Paralysis of the Hind Quarters. Seen occasionally in cattle. The seat of this trouble is in that part of the spinal cord situated at the loins; as the animal always retains its power of movement over the front part of the body. While we say paralysis, it is not complete, as the muscular coat of the intestines and bladder have the power of contraction, and the skin also is sensitive. It sometimes happens before calving but more frequently after calving. The pressure of the fetus on the pelvic nerves is undoubtedly the cause of the paralysis. The condition may remain for some time, during which period the animal must be carefully nursed. Blistering liniments may be applied over the loins with considerable friction. In slow cases of recovery electrical treatments sometimes are of value. Cases which occur before parturition recover without difficulty.



SIR PIERTERTJE ORMSBY MERCEDES 14th

A 2,750 pound Holstein Grand Champion—Minnesota and Wisconsin State Fairs, 1917.
Owned by Marlow & McCargar, Mankato, Minn.

Inflammation of the Eye in cattle is in all cases where a number of the herd are infected, due to a specific organism or germ.

Symptoms noticed are a slight watery discharge from the eye; the lids are swollen, the upper lid being dropped; the cornea or transparent part of the eye becomes white, so much so that the light rays cannot penetrate into the eye and the animal becomes blind. In a short time we have a bulging of the eye-ball and ulceration, as a result of which the contents of the eye escape and permanent blindness follows. Treatment is to separate at once all infected animals, bathing the eyes with a mild disinfectant. Special treatment is desirable where the eyeball has become white or is bulging.

surgical tuberculosis, meaning it affects certain glands of the neck, or certain joints which can be operated upon with more or less success.

Symptoms of this disease are almost impossible to find. In fact, the only known symptom is an enlargement of the glands in the throat, which appear like a round object in the space below the ear and just above the larynx or Adam's Apple, corresponding to the enlarged glands seen in the region of the neck in human beings. As the gland enlarges it presses upon the windpipe causing difficult breathing. Probably only three per cent of diseased cattle show this symptom.

It is generally supposed that coughing

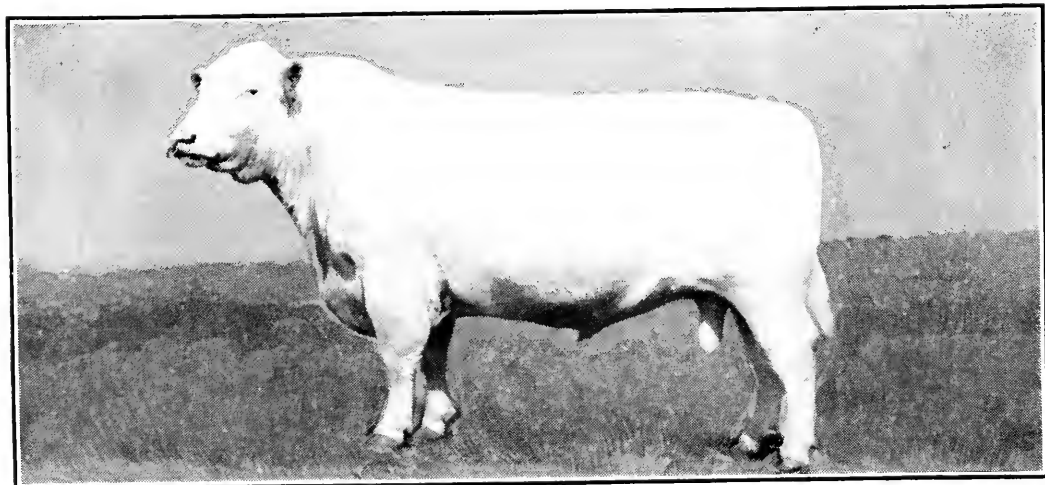

GRAND CHAMPION—POLLED DURHAM BULL—BRED IN STRAIGHT CREEK, KANSAS

TUBERCULOSIS

This is an infectious disease very prevalent in cattle. It is communicated readily to swine which suffer very seriously, and as a rule it is acquired by swine from drinking milk from diseased cows or by feeding behind tuberculous cattle. In man the germ gains entrance into the body from milk and in many cases is seen in what is known as

indicates its presence. When an animal becomes thin from no apparent cause, suspicion is excited. This condition may arise from many causes other than tuberculosis. Coughing is almost a natural thing in cattle and in all animals which chew their cud, the food being vomited back into the mouth for proper chewing and masticating, constantly causing some little irritation.

The **tuberculin test** is the only agent we have at the present time, which is capable of picking out tuberculous animals, and it behooves every breeder to ascertain if his herd is clean. Cattle free from tuberculosis are cheaper to feed and cheaper to keep. Keeping diseased cattle is a waste of time and a menace to the swine on the farm and those who drink and eat dairy products.

The tuberculin test should be applied only by reliable, conscientious veterinarians, and when once the herd is clean only animals from known healthy herds should be added. If farmers are contemplating the purchase of pure bred cattle they should buy only from some accredited tuberculous-free herds. The state veterinarian can give the names of the breeders whose herds are so listed.

If an animal suspected of the disease dies, an examination of the carcass will determine whether or not the disease exists. The lungs are to be removed and by passing the hand over its surface nodules or lumps will be felt. On cutting into these lumps they will be found to contain soft cheesy pus, or if of long standing will be hard and gritty. The glands on the windpipe between the lungs should also be cut to ascertain if any pus is present.

When diseased animals are removed from a herd, the stalls, mangers, and water troughs are to be disinfected as in all contagious diseases.

First remove all litter and dirt, then sprinkle the stalls, mangers and troughs with a solution containing six ounces of lysol to a gallon of water. Allow this to dry. The sides of stalls and woodwork in the barn can then be whitewashed, adding six ounces of chloride of lime to each gallon of white-wash.

COWS' TEETH ACCORDING TO AGE

Cattle, like horses, have two sets of teeth, the temporary or milk teeth, and later the permanent teeth, which permanent teeth are of course larger than the milk because of the increase in the size of the animal's jaw as it becomes older.

Oftentimes the calf is born with the central pair of temporary teeth. The balance

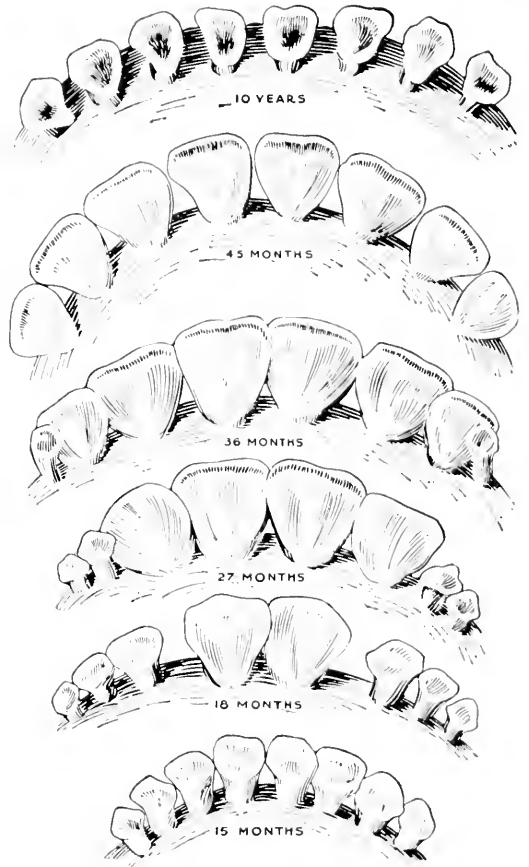

of the temporary teeth come in within the first month. These incisor teeth which come in four pairs are in the lower jaw only operating against a cartilaginous pad in the upper jaw.

At about eighteen months old the central pair of milk teeth are replaced by permanent ones. These are quickly recognized, as they are twice as broad as the milk teeth.

Each succeeding pair of permanent teeth appear at intervals of about nine months' time, but this varies considerably according to conditions, being apt to exceed this time. As a rule each pair is through and in service at the following ages:

First pair of Permanent Teeth.....	18 months
Second pair of Permanent Teeth	27 months
Third pair of Permanent Teeth	36 months
Fourth pair of Permanent Teeth	45 months

Some authorities give the time of appearance of the permanent teeth as follows: First permanent pair at two years old, second pair at three, third pair at four, and fourth pair at five years old.

Cows' teeth undergo but little change for years and are never fixed tightly in the jaw as the permanent teeth of a horse.

Warts are frequently seen on young animals in such abundance as to make them look unsightly. The skin of the abdomen and side of the neck may be almost covered with them. Just what induces the growth of these cutaneous tumors, it is impossible to say. Many writers recommend their removal with a knife or tying a string tightly around their base. To do this in some cases would be almost equal to skinning the animal. Little alarm need be felt because of this condition.

The probabilities are they will disappear after animal gets to pasture.

Warble Fly, sometimes spoken of as Gad Fly, resembles to some extent the Bot Fly affecting horses.

In certain sections of the country the warble fly is quite prevalent and as it causes a peculiar condition in cattle, attention is called to it. The fly is very similar to the bot fly, laying its eggs somewhere

upon the legs of cattle. Its flight is extremely rapid and quite often unseen. Its presence is detected by the actions of the cattle. The fly deposits its eggs on the hair

of the legs, which are taken into the mouth when the animal licks

the part. The young larvae find a resting place back in the throat,

from whence they gradually find

their way possibly by following the path

of least resistance until they reach

the back of the animal where they

become lodged and complete part

of their life cycle. By the

late winter months they are almost

matured, and their presence is

indicated by small swellings appearing on the

cow's back. These swellings

become soft and the warble is released, then buries itself in the ground and

emerges in a few days as a full grown fly.

Prevention. In sections where the fly is known, grease, vaseline or some mild oil



"WOODBINE LAD." Prize Winning Hereford Bull—Henrietta, Texas



"GAMBOGE VELLUM MAJESTY," Owned by M. D. Munn, St. Paul. A Grand Champion Jersey Bull.

should be rubbed lightly over the legs of animals or some good fly repellent may be used very effectively.

When the small swellings are seen on the backs of cattle in the late winter months, they should be opened with a sharp knife and the grub squeezed out and destroyed.

with some swelling and tenderness above the hoof. (This condition may be mistaken for foul in the foot. See sheep.)

In a short time we have sloughing of the tissues above the hoof, which does not occur in any disease other than ergotism.

Treatment consists of course in a complete change of food. Laxatives must be given to purge the ergot from the blood, and the raw places treated with healing lotions.

Sorghum Poisoning. In sections where sorghum is raised we occasionally experience trouble as a result of cattle eating the stalks. This is particularly noticed in years when the growth of sorghum has been stunted on account of drouth. Animals are apparently in the best of health and in a short time after pasturing in the corn field may drop dead.

Cow Pox. A disease of the cow; an eruption on the teats and udder.

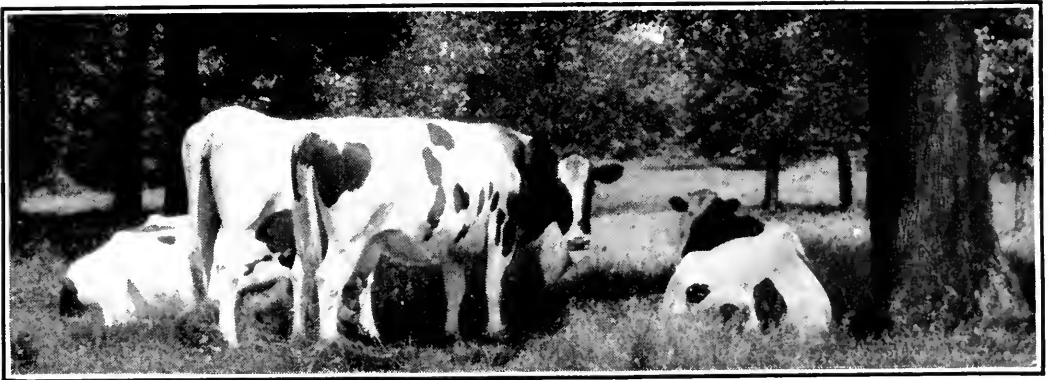

CONTENTED COWS

CONSTITUTIONAL DISEASES

Ergotism. When grain or corn stalks are affected with "smut" and young cattle partake too freely, we have a peculiar condition of the lower extremities, extending from the hoof to the fetlock, in which the parts become gangrenous or slough.

Cause is due to ergot, a fungus which destroys the grain and virtually takes its place. It is recognized by its blue-black appearance, and affects the seed of any growing crop. It has the peculiar property when taken into the system of contracting blood vessels. The blood circulation of the feet is perhaps the slowest in any portion of the body, and the blood vessels being very small become contracted still smaller, by action of the ergot, with the result of a stoppage of the circulation and consequent death or gangrene of the parts.

The first symptom is that of lameness with small vesicles in the cleft of the foot,

The vesicles are flat and depressed in the center; there may be only one or two on the udder or teat. In about a week the pock may be about the size of a small button, and a few days later gives the appearance of a black scab which finally falls off about the third week. The disease may be transmitted to the milker, and from him to other cows. Apply soothing ointment to the parts.



"LONGWATER DAIRY MAID," A \$6,150 Guernsey Cow Longwater Farms—North Easton, Mass.



"KING SEGIS PONTIAC ALCARTRA." A \$53,000.00 Champion Holstein Bull, Stevens Bros., Liverpool, N. Y.
 THE HOLSTEIN-FRIESIAN breed of dairy cattle originated in Holland. They are the largest in size of the dairy breeds. Bulls weigh 1700 to 2200 lbs.; cows 1400 to 1800 lbs. Color is black and white. While the Jersey type is noted for the fine quality of milk the Holstein is noted for the great quantity. It is this type that is used largely by dairy farms supplying larger cities.

CONTAGIOUS AND INFECTIOUS DISEASES

Rabies, or hydrophobia. This disease is prevalent to a greater or less extent in every state, and is a serious problem to stock owners adjacent to large cities.

The disease can only be produced by the bite of a rabid animal. It is essentially a dog disease and infectious to every species of domestic animal and man. We find that the closer the bite is to the head, the quicker is the incubation period. The period of incubation is longer in the summer than in the winter. It has always been supposed that rabies was a disease of the summer months, but statistics will show a greater mortality in live stock and in the human being during the winter months.

Symptoms. In cattle we have one symptom that predominates over all others; i. e., a continual bawling. It reminds one of a cow that has lost its calf. It will be noticed

considerable saliva hangs from the mouth, the animal makes attempts to eat and drink, but is unable to do so. Occasionally in addition to the bawling, we see constant straining efforts.

If there is any knowledge of an animal having been bitten by a dog, great care should be used by all, when handling the patient. A small cut or abrasion of the skin may be sufficient to permit the entry of the germ, should any of the saliva come in contact with the cut.

Treatment. In the human being we have the Pasteur treatment, which would probably be just as efficacious in animals, but the cost is prohibitive. Animal should be placed by itself and the humane owner would have it killed as early as possible. Cattle rarely live more than three or four days after the symptoms appear.

Prevention. Keep your own dog confined to the premises and make active war on stray dogs or any that worry live stock.

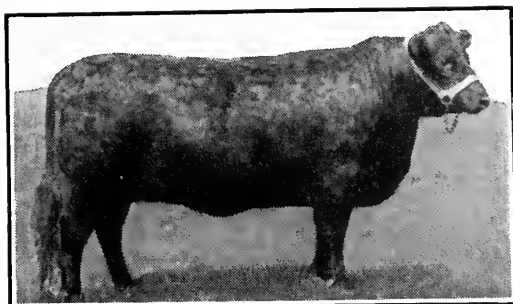

SENIOR AND GRAND CHAMPION GALLOWAY BULL
The Galloway breed originated in Scotland, noted for fine long hair used for wats and robes. All Galloways are black and hornless

CONTAGIOUS ABORTION

Possibly one of the most dreaded diseases confronting the stockman. The cause is generally accepted to be a specific organism. We have two forms, an early and late. In the early form the abortion may occur within two months while the late occurs about the seventh month.

When the disease makes its appearance there are four fundamental principles to follow:

- (1) Do not sell any of the herd.
- (2) Do not place any fresh animals in the herd.
- (3) Do not breed aborters for at least three months after aborting.
- (4) Thorough and continual cleaning and disinfection of the barn.

To sell aborters means you help spread the disease. To place fresh animals in the herd means they will also come down with the disease and thus you will breed it and retain it on the premises so much longer. This disease like all others produces at some time immunity, therefore the herd should be kept intact with the result that sooner or later the disease dies out.

Various remedies are on the market at the present time; however none can be called specific. In some cases their applica-

tion seems to have remedied the trouble but as a matter of fact the disease has simply died out of its own accord.

Prominent investigators the world over are still carrying on experimental and research work with a view of learning something definite as to its manner of spread and positive treatment.

In Great Britain the method of dealing with the disease is to inject all young female cattle with the active virus which is the cause of the disease. This produces an immunity, just as vaccinating causes an immunity against smallpox.

BLACK LEG

A disease which attacks young animals from one month to two years of age. Probably animals ranging around eighteen months are the most susceptible. It is more prevalent while animals are on pasture and appears to attack those that are in the best of condition.

Symptoms are easily discerned, and consist of swellings which may form on any part of the body, usually on the shoulders

and thighs, in which case we have some lameness. When these swellings are pressed they give forth a crackling sound which can also be noticed by the hand. If cut into the tissue is dark and a frothy, black fluid exudes.

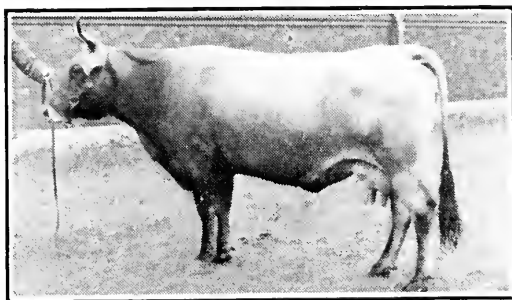

"SWISS VALLEY GIRL"

A Grand Champion. Brown Swiss cattle are dual purpose—milk and beef. Weight, bulls 1500 to 2000 lbs.; cows 1200 to 1500 lbs.



"QUEEN MILLY OF SUN DANCE"

Grand Champion Angus Cow. Raised at Burlington Junction, Mo.

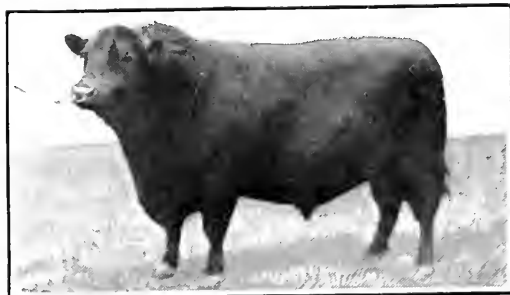

SENIOR CHAMPION ANGUS BULL

Angus are beef cattle; fatten easily; all black and hornless.

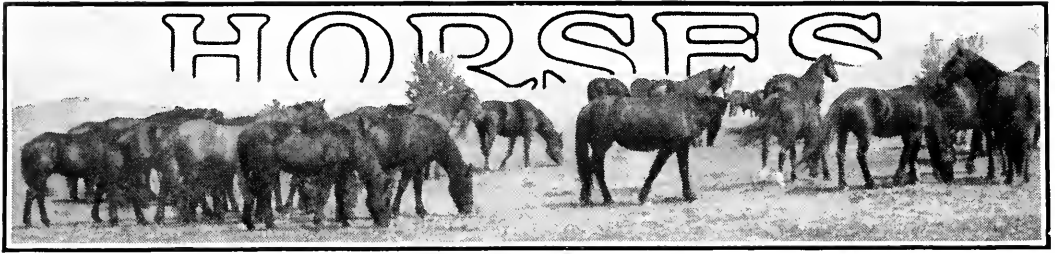

Fractures of Bones. A fracture is termed simple when the bone is broken across; comminuted, when broken in fragments; and compound when the broken ends protrude through the skin.

The bones most commonly fractured are the long bone below the knee and hock; the bone running from the stifle joint to the hock;

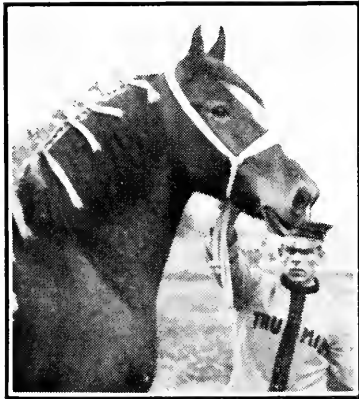

sometimes the corner of the large hip bone; the latter fracture as a rule due to striking the angle of hip bone against the barn door as horse centers. Fractures of the long

bones are generally the result of kicks. If an animal is seen to be kicked in the region mentioned and becomes lame it is well to keep it in complete rest until the exact nature of the injury is established.

When fractures are known to exist, it becomes necessary to at once bring the broken parts in exact position and so maintained, while a bandage of some woolen material about four inches broad is applied. This should be of sufficient thickness so that stiff card board or leather splints can be applied thereon (one to the front and one at the back) will not chafe the skin. The material for the splints should be moistened so that when dry they will conform to the bandages. Plaster of Paris bandages are then to be applied over the splints. Fractures in old horses seldom unite and it is policy to destroy them.

WOUNDS

All wounds are more or less painful and due care should be taken when handling them. No strong, painful remedies should

be applied. Bleeding should always be checked and the parts made as dry as possible. In case an artery is cut, indicated by a fine stream that shoots out from the wound, apply a piece of cotton batting, gauze, or other soft material that has been wrung out in a mild disinfectant. In case a bandage cannot be applied and the wound is large, pack the cavity with the material recommended. These bandages or packings should be left in place about twenty-four hours, after which there is little danger of hemorrhage.

Nail Punctures of the Feet. The feet of all animals are very sensitive and almost any injury to them will cause the animal to exhibit more or less pain, depending on the severity of the injury. It is good practice when an animal becomes suddenly lame to at once examine the foot. If due to a nail, the offender is to be at once removed. The puncture should be enlarged in a cup-like fashion, cleaned out and iodine or some good disinfectant poured in and a layer of soft material placed immediately over the

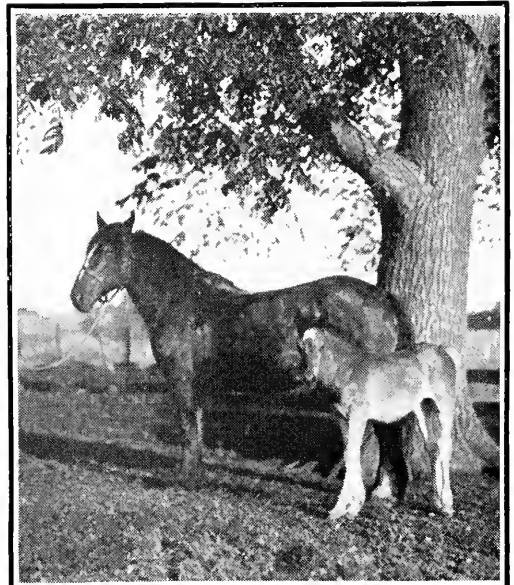

A WELCOME LITTLE STRANGER

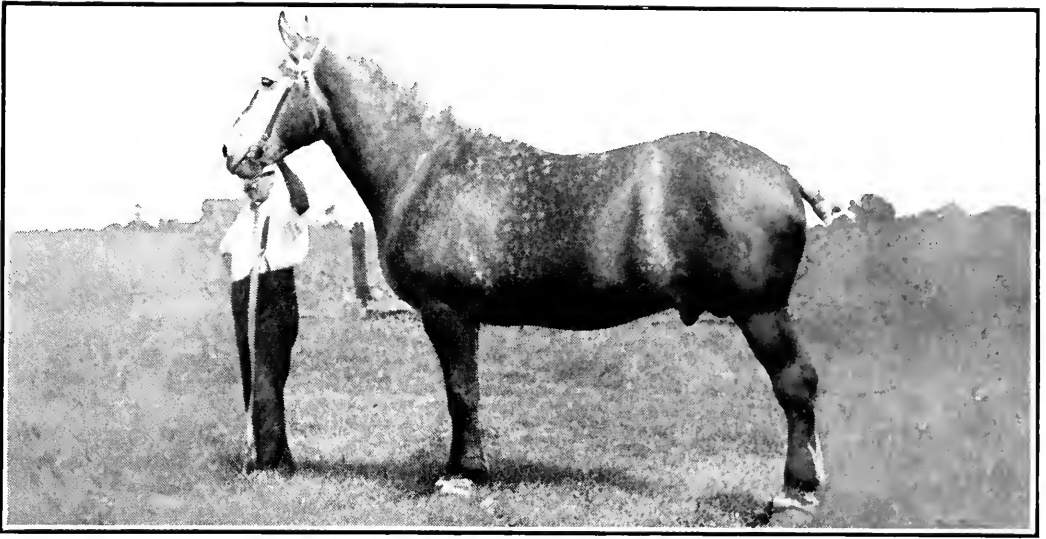

"VINAY"—CHAMPION PERCHERON STALLION OF FRANCE—Imported by W. G. Dunham, Wayne, Ill.

PERCHERON draft horses are from La Perche, France. They attain massive size and are noted for their quality, action and endurance. Stallions weigh from 1700 to 2000 lbs.; mares 1400 to 1800 lbs. The height of Stallions ranges from 15½ to 17 hands—mares 15 to 16½. Color is exceedingly variable—black and dapple gray predominate. This is the most common type of heavy horse in the United States.

part. A small sack should then be drawn over the hoof and held in place with a bandage above the hoof.

Punctures near the toe in front of the frog are always serious, their seriousness depreciating as the injury extends back to the heel. It is a well known fact that injuries of the hind feet are the more serious and cause rapid loss of flesh. Shoe calks are frequent in the winter months and care should be taken when they occur to allow

drainage by cutting away the horn in a crescent shape immediately below the calk, clearing out all material driven in and then applying a poultice.

Laminitis, or Founder, is brought about by excessive feeding, and also by the sudden checking of perspiration, as well as by the drinking of very cold water when the animal is heated. Driving on very hard roads is apt to induce this trouble and it sometimes follows foaling. It appears

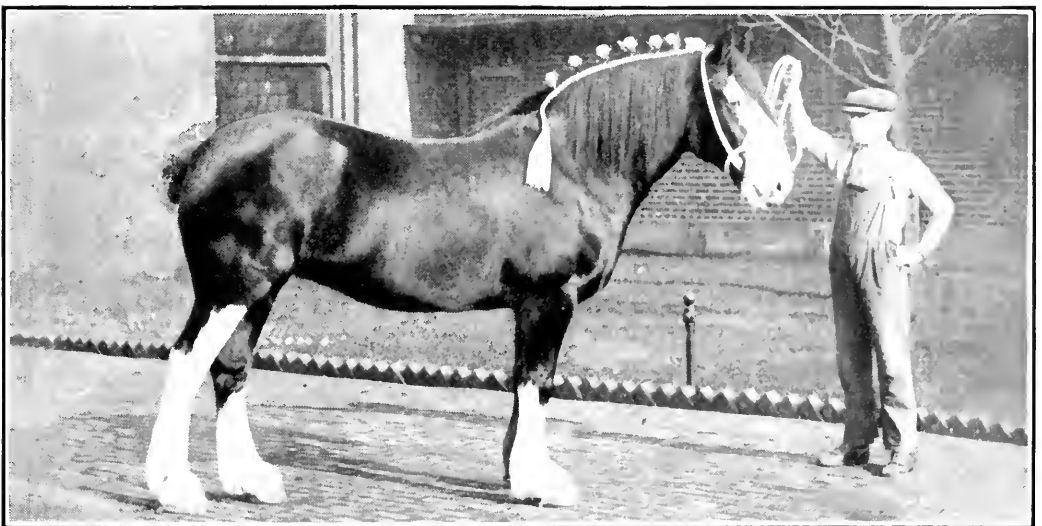

"HARVIESTOUN BARONESS"—GRAND CHAMPION CLYDESDALE MARE, INTERNATIONAL EXPOSITION

CLYDESDALE draft horses originated in Scotland. They are very active though not so heavy as the Shire or so massive as the Percheron. Stallions weigh 1600 lbs. and up, mares 1400 lbs. and up. The height is from 15 to 16½ hands. Bay or brown with white on forehead and on legs below knees most popular, though there are blacks, grays and chestnuts. Like the Shire breed long hair back of the cannons below the knees is characteristic.

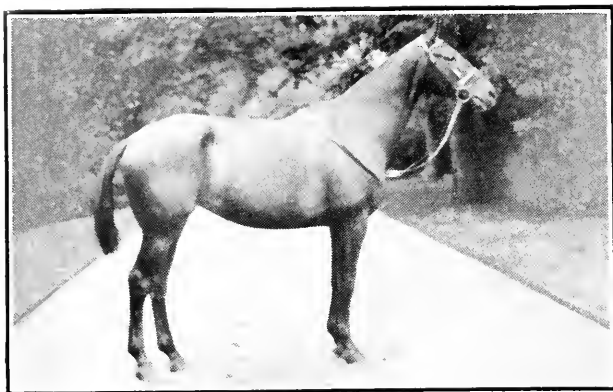

THE AMERICAN SADDLE HORSE

A native of the United States, chiefly Kentucky, Virginia and Missouri. Saddlers are of two classes—1st, a walk-trot-canter horse; 2nd, the five-gaited horse—walk-trot-canter-rack; and running, walk or fox trot or slow pace.

as a rule in front feet and when first seen animal presents a most alarming condition, standing with its hind feet advanced as far forward as possible to relieve the pressure of the body on the front feet. The horse sweats profusely from the extreme pain and will not move in any direction. Immediate treatment is required by removing the shoes and the application of hot poultices of bran, linseed meal or any material of a like nature which will hold the heat.

DIGESTIVE TROUBLES

Teeth. Splitting of the back teeth is quite a common occurrence and, like all teeth troubles, is called to the attention of the owner by finding in the manger partly chewed masses of hay, which have been dropped from the mouth. In some cases a very offensive odor is noticed. Animal should be given

sloppy feed, which does not need masticating until the services of an expert can be called.

Tongue. We find this member sometimes injured from accidental biting, which may happen when a horse suddenly stumbles. Most frequently the tongue is cut by a strap or rope put into the mouth of unruly animals and spoken of as a half hitch.

Colics are invariably due to mistakes in feeding or watering and as prevention in all cases is the best treatment, every care should be exercised by the owner.

If by mischance an animal becomes colicky, give gentle walking exercise as this tends to cause evacuation of the bowels, and lessens the pain as the irritant passes along the intestinal canal.



"WATER BOY" A FAMOUS THOROUGHBRED RUNNING HORSE
Lexington, Ky.

The "Thoroughbred" breed of running horses originated in England

All hay and litter should be cleaned from the manger and stall before animal is

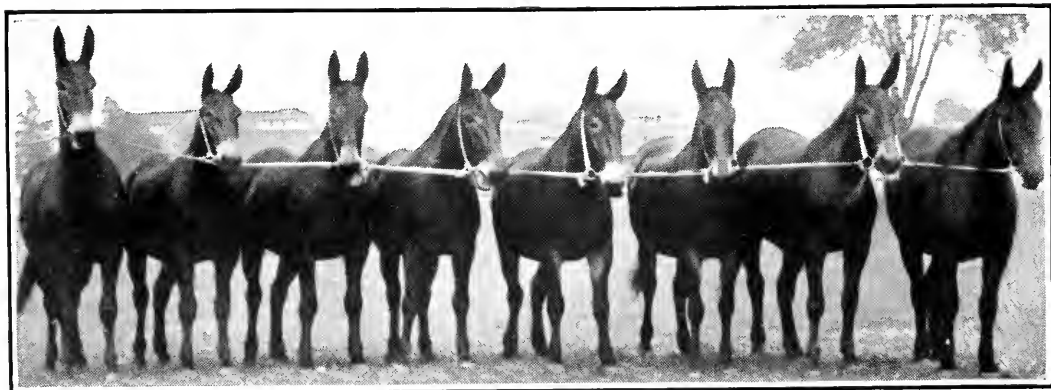

A STRING OF HIGH CLASS BIG MULES AT THE ILLINOIS STATE FAIR

Splendid examples of the results of careful breeding and management.

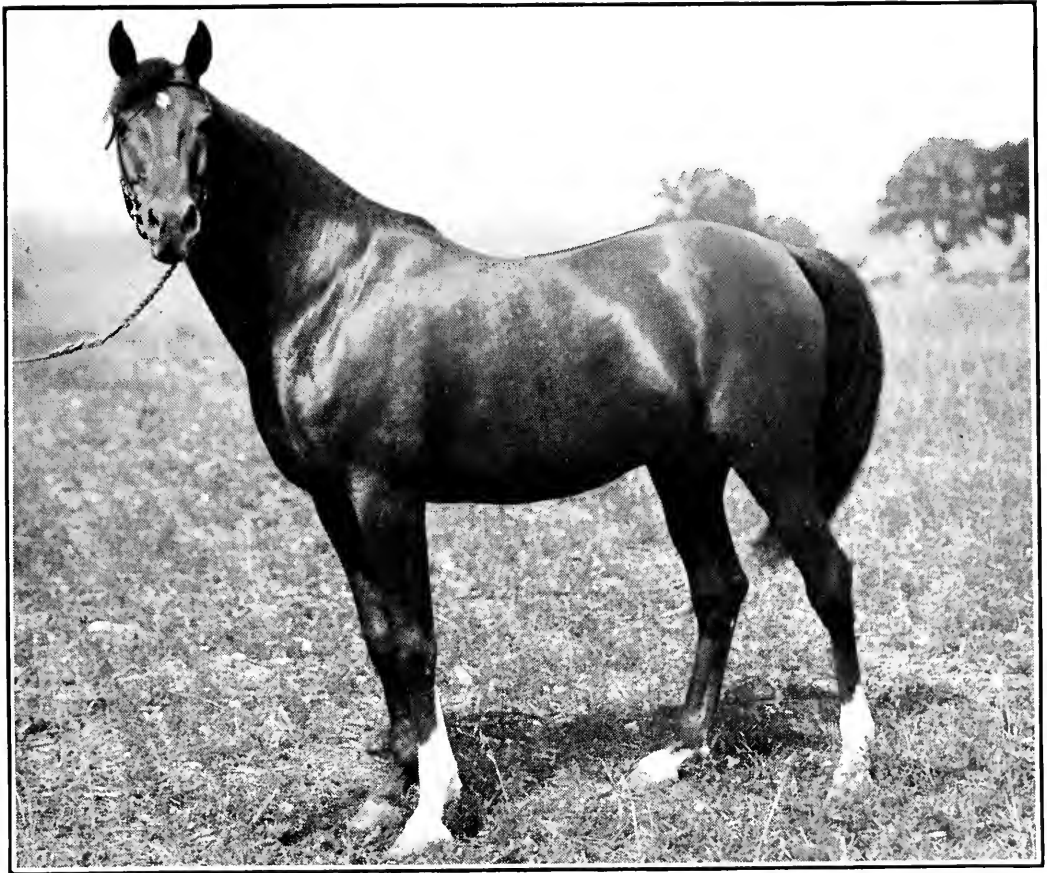

ARABIAN STALLION "KHALED"—Hartman Stock Farm, Columbus, Ohio

The ARABIAN breed of horses originated in Arabia. This breed gave the English Thoroughbred running horse its great speed and endurance. They are extremely intelligent and docile. They make excellent officers' mounts and are used for string polo ponies.

returned to it, and patient should be starved for about twelve hours and then fed very lightly.

Choking. This trouble is very rare except in greedy horses, and then is occasionally seen when eating grain. The symptoms are somewhat puzzling unless one is familiar with them. The horse is noticed to lift its nose up in the air extending its neck and strains in its attempt to swallow.

The choke may be located anywhere along the gullet; quite frequently it is found in the part running down from the neck and may be located by sight on the left side parallel with the windpipe. If due to grain or soft hay, and in the region of the neck, it may be broken down by manipulation.

Poisoning. It is seldom we see a horse suffering from any form of poisoning, induced by accident. The sudden death of animals which is usually laid to poison is in almost every case due to some other cause than poison.

Lung Diseases. No attempt will be made to enter into these. It is enough to say that the majority are caused by exposure. Use common sense and when a stop is necessary do not let the horse face the wind. Animals on the range very seldom are affected with lung troubles, although exposed to a variety of climatic conditions. The reason for this is they at all times feed with the wind.

Kidneys. As a matter of fact, the owner may efface from his mind that his horse has any form of kidney trouble. These cases are so rare as to be a novelty.

We occasionally meet with a form of diabetes in which the patient urinates so profusely as to cause the owner some consternation. This condition is caused by mouldy oats, and is remedied by changing the feed.

Circulation of the Blood. Only one peculiar condition under this head will be described, which is only seen in horses driven

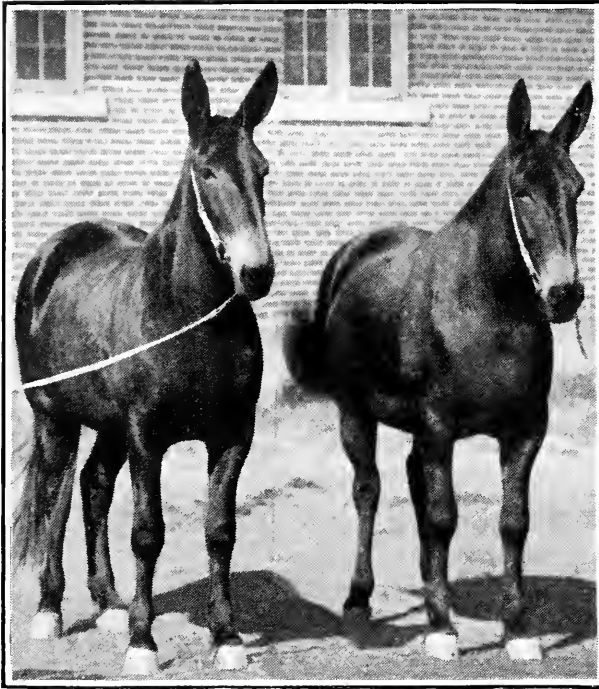

PRIZE WINNING TEAM OF MULES, IOWA, 1916

faster than a walk. While not very common the condition may arise at some time, hence owners should know what to do. After the animal has been driven for a short distance it is noticed to become extremely lame in one hind leg, finally falling in the harness. After a short rest it comes to its feet and lameness has disappeared only to be evident after being again driven for a short distance. This condition is due to a parasite plugging the principal artery supplying the leg with blood. This parasite or worm is very small and finds its home in certain blood vessels, causing a thickening of the vessel walls, thus shutting off the blood supply.

When the condition described arises, animal should be used only for slow work.

Nervous Diseases. Under this heading will be described a condition due to faulty feeding and often considered to be a form of paralysis of the hind quarters. The common name given is azoturia, or black water. This trouble is seldom seen in stallions, mares with colt, or animals in poor condition. In the horse that is well ribbed up and an easy keeper, it is very common. The exact

nature of the trouble is not understood. We know horses are prone to this condition if laid off from hard work for a period of from one day to a week or more, and their grain ration has not been reduced. After a rest the animal is put to work, which at first is performed with willingness. After going perhaps half a mile, it is noticed animal sweats and knuckles over in one hind leg. In a short time it drops and is unable to rise, and may possibly lie quiet, or, if animal is of a nervous temperament, becomes excited. This condition is a most unsatisfactory one to treat, the mortality in the corn belt region being at least 50 per cent.

Prevention. When well conditioned animals are taken out of work, because of bad weather or other causes, the grain should be cut at least one-half. If this is not done, and after being put to work the animal loses its spirit and shows signs of dragging back or knuckling,

then a stop should at once be made, the harness removed and animal allowed to rest for a while and then slowly led to the nearest barn.

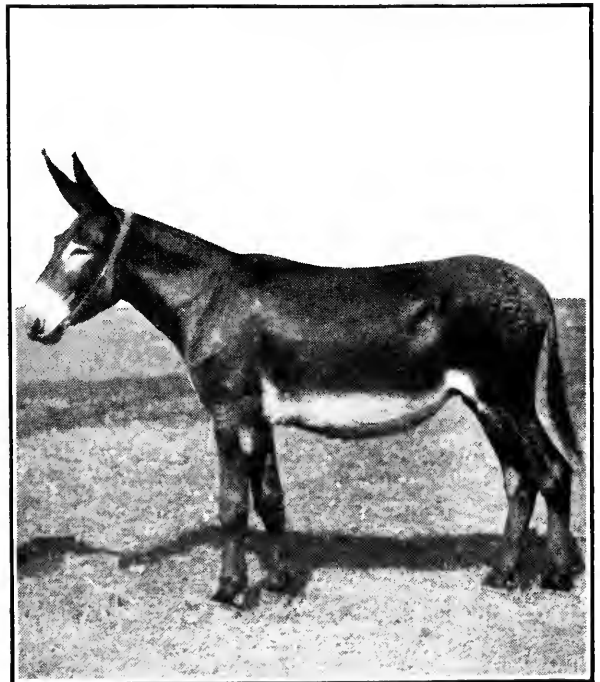

GRAND CHAMPION MISSOURI STATE FAIR, 1916
Owned by L. Knopf, Cole Camp, Mo.



IMPORTED PERCHERON MARES—Wayne, Ill.

BREEDING TABLE FOR LIVE STOCK

TIME OF SERVICE TO APPROXIMATE DATE OF PRODUCTION

PERIOD GIVEN MAY VARY SLIGHTLY

TIME OF SERVICE	PRODUCTION			
	MARES	COWS	EWES	SOWS
January 1	December 6	October 10	May 30	April 24
January 15	December 20	October 24	June 13	May 8
January 29	January 3	November 7	June 27	May 22
February 12	January 17	November 21	July 11	June 5
February 26	January 31	December 5	July 25	June 19
March 12	February 14	December 19	August 8	July 3
March 26	February 28	January 2	August 22	July 17
April 9	March 14	January 16	September 5	July 31
April 23	March 28	January 30	September 19	August 14
May 7	April 11	February 13	October 3	August 28
May 21	April 25	February 27	October 17	September 11
June 4	May 9	March 13	October 31	September 25
June 18	May 23	March 27	November 14	October 9
July 2	June 6	April 10	November 28	October 23
July 16	June 20	April 24	December 12	November 6
July 30	July 4	May 8	December 24	November 20
August 13	July 18	May 22	January 9	December 4
August 27	August 1	June 5	January 23	December 18
September 10	August 15	June 19	February 6	January 1
September 24	August 29	July 3	February 20	January 15
October 8	September 12	July 17	March 6	January 29
October 22	September 26	July 31	March 20	February 12
November 5	October 10	August 14	April 3	February 26
November 19	October 24	August 28	April 17	March 12
December 3	November 7	September 11	May 1	March 26
December 17	November 21	September 25	May 15	April 9
December 31	December 5	October 9	May 29	April 23

ANATOMICAL CHARTS OF LIVE STOCK

Anatomical Chart of Cattle

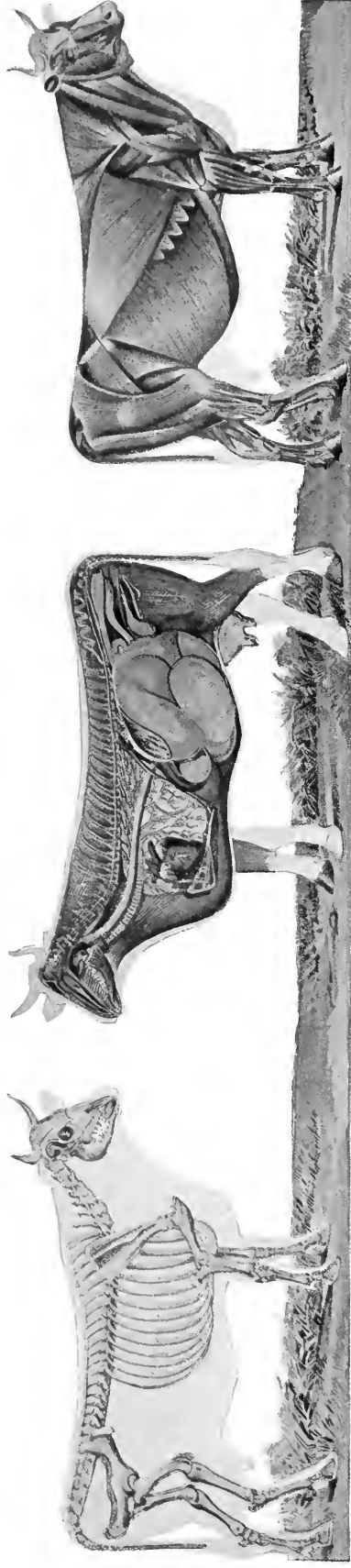

Skeleton of Cattle

Internal Organs

The Muscular System

Anatomical Chart of Horses

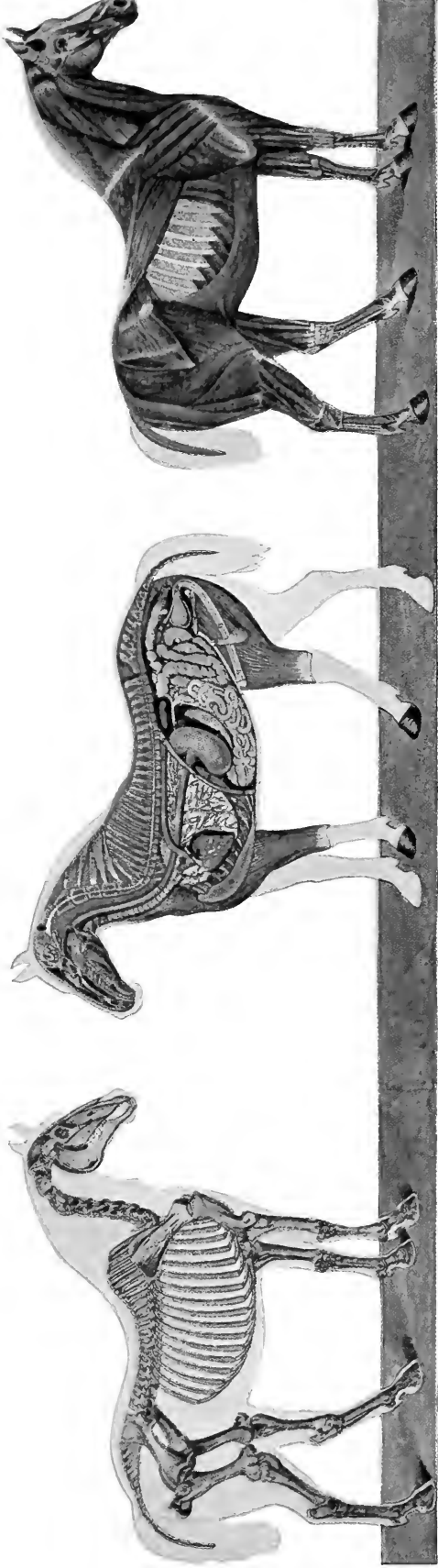

Skeleton of Horse

Internal Organs

The Muscular System

Anatomical Chart of Swine

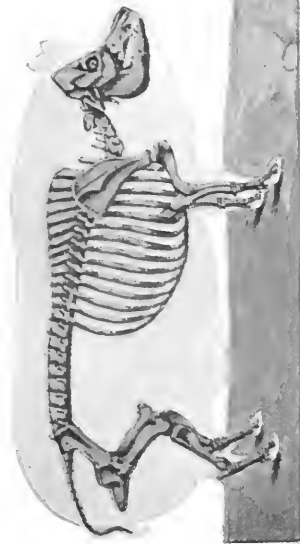

Skeleton of Swine

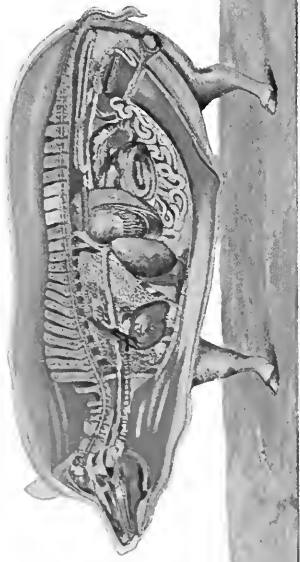

Internal Organs



The Muscular System

Anatomical Chart of Sheep

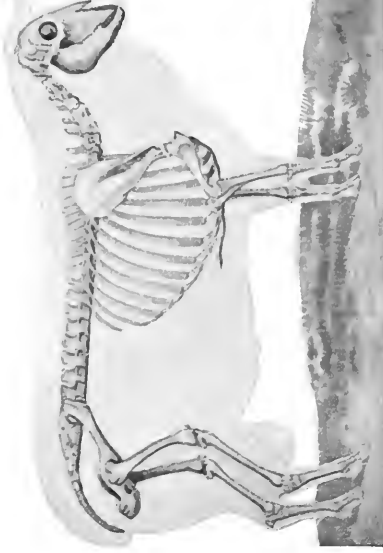

Skeleton of Sheep

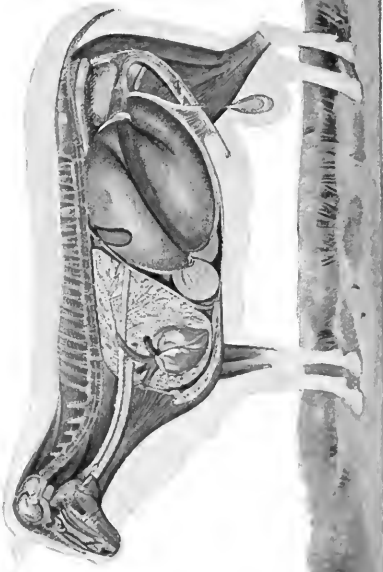

Internal Organs

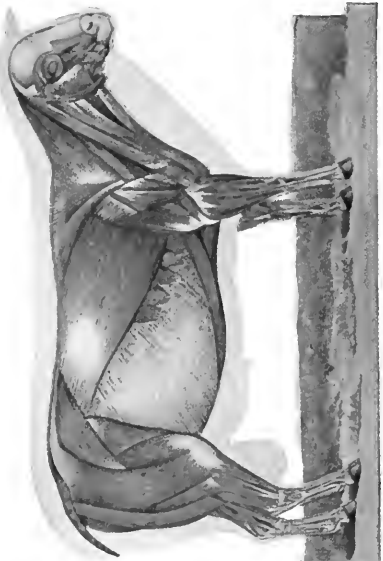

The Muscular System

PARASITES

The horse is host of a variety of worms. Each has its own particular habitat. Some thrive in the blood vessels, others in the stomach or some portion of the intestines. Unless in very large numbers no bad results follow. In young colts if badly infested a dropsical condition makes its appearance and expert treatment is then necessary. The feeding of worm powders and liquids to horses rarely accomplishes very much. Like other conditions the infestation of animals is a result of an impure water supply. Owners should take care to see that their live stock are given well water or that obtained from running streams.

HEAT OR SUNSTROKE

This condition is frequently seen during the hot weather, and at a time when the farmer is busy haying or harvesting. Symptoms are overlooked in the beginning, and it is not until the animal stops or drops to the ground that the driver realizes there is something wrong. Were the animals' temperature to be taken it would be seen the thermometer would register its full length, 110 degrees.

If three horses are working abreast, the center horse would in all likelihood be the one to be affected, for the reason it gathers

heat from the animal on each side, together with the direct rays of the sun.

Treatment. In extremely hot weather horses should be given plenty of time to feed, and no direct hurry should be made to work them after the noon meal. In hot weather the harness should be taken off, immediately animals go to their stalls and they should be given a sponge bath. Water should be given them in small quantities before they are grained. In the afternoon water should be taken to the field and animals given a drink at frequent intervals. A sponge bath while in the harness is an excellent thing, as it not only refreshes them but is also cooling.

When animals come down with sunstroke, the harness must at once be removed, and a shelter erected. Ice cold water or wet blankets should be constantly applied to the body and if possible ice packs to the head, and cracked ice can be put into the side of the mouth.

If a large injection pump is available a painful of cold water can be injected into the rectum and repeated at frequent intervals. After recovery animal is to be given a complete rest and should not again be worked on hot days, unless it be for short spells in the early morning or late afternoon.

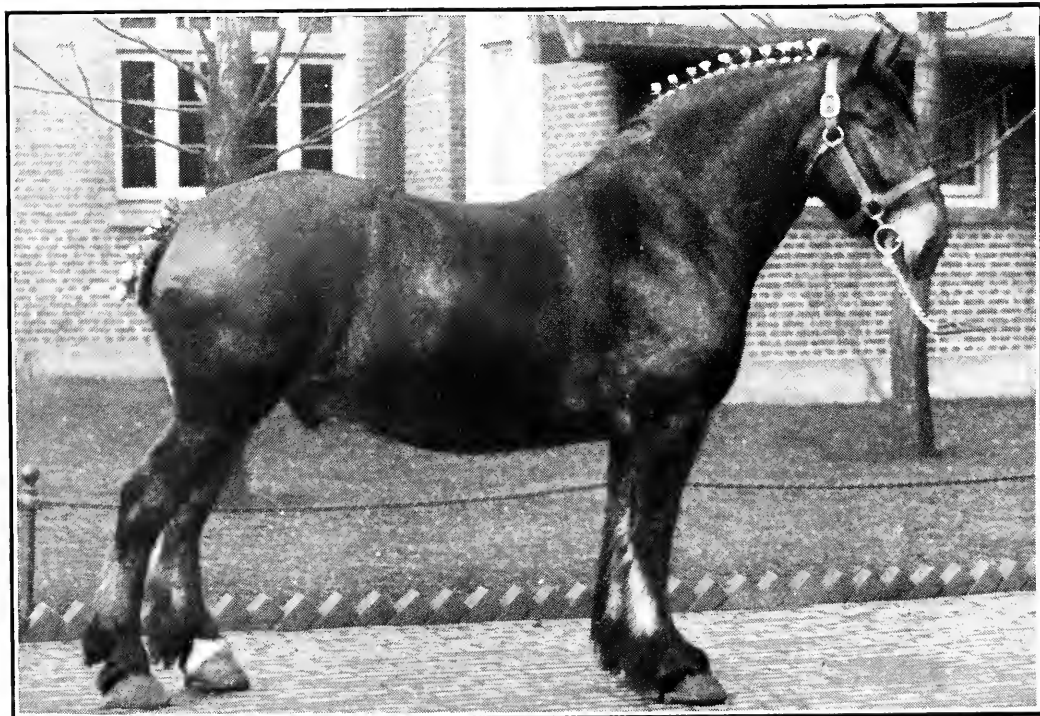

GRAND CHAMPION CLYDESDALE GELDING—International Exposition 1917

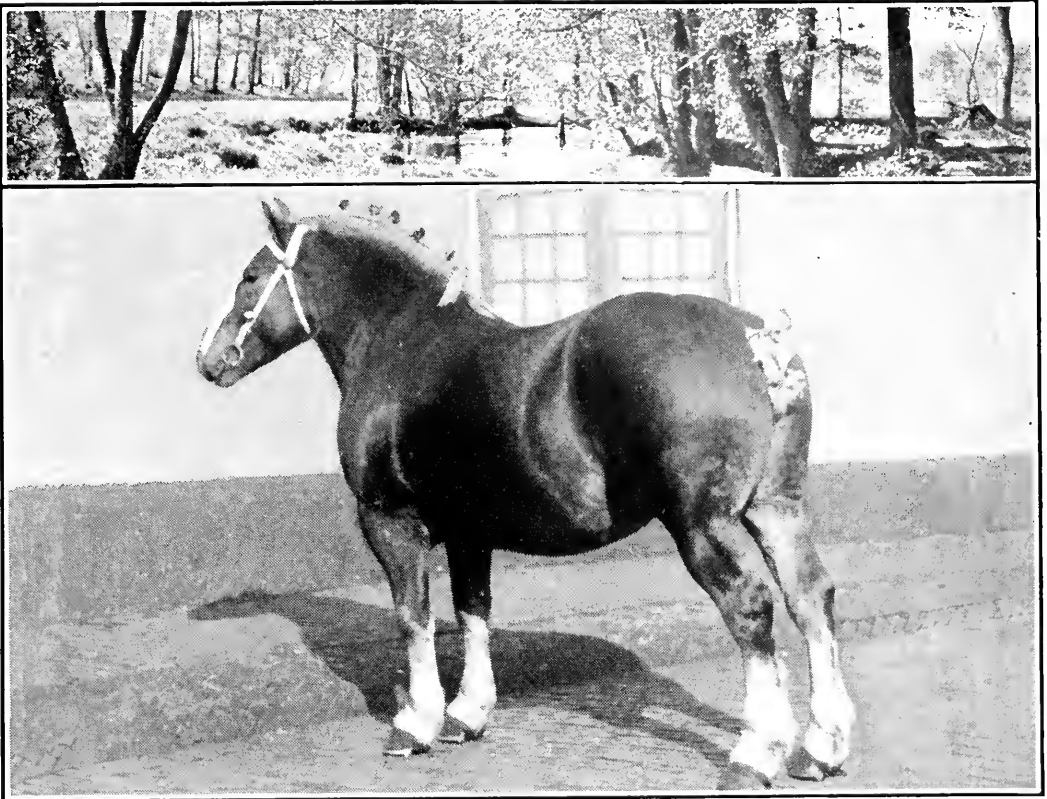

"LISTIA"—GRAND CHAMPION BELGIAN MARE—Owned by C. Irvine, Ankeny, Iowa.

The BELGIAN draft horse is a native of Belgium. They vary greatly in weight and height. Stallions from Arkansas weigh about 1200 lbs., those from Flanders weigh 2000 lbs., the height varying accordingly. Chestnuts are popular, with numerous roans, bays and browns. They lack the heavy hair on legs as on Clydesdales and Shires.

CEREBRO SPINAL MENINGITIS

Again we have a peculiar condition due to lack of care in the food of the horse. This is quite serious and causes alarming losses during the feeding months.

Cause is generally accepted now to be due to a fungus which is found in musty oats, oat straw and probably corn.

Symptoms are usually quite rapid in their onset. Affected animal is found to be down and unable to rise. Other horses make attempts to eat and drink but cannot swallow. A stringy discharge of saliva hangs from the mouth and the breath gives forth a peculiar mawkish smell. No reliable treatment has yet been found to combat this condition. One investigator has produced a serum which gives promise of being a specific, but further experiments are yet required before it can be recommended.

Following wet Falls great care should be exercised in feeding grain which has become tainted, and oat straw should be fed with much caution. It is particularly necessary to keep horses away from straw stacks.

SKIN DISEASES

Lice in young horses are quite common and a source of annoyance to the up-to-date owner. Many times their presence seems to indicate a lack of care and attention. If the owner knew how much agony and loss of flesh that lice cause, he would do all in his power to destroy the pests. Various remedies in the form of powders and liquids are recommended and meet with varying results.

One of the most effective treatments is that of equal parts of cottonseed oil and kerosene which should be applied quite warm. If large areas are to be treated it should be done only during mild weather and repeated every two weeks.

Bleeding Warts occasionally make their appearance on the skin, and, as the name implies, they present a raw, bloody surface. While they are not regarded with any degree of alarm, most owners are desirous of a remedy. Such will be found by daily painting the raw surface with nitric acid, care being taken not to let any of the remedy touch the sound skin.

CONTAGIOUS AND INFECTIOUS DISEASES

Glanders is one of the most insidious diseases of the horse, manifesting itself by a discharge from the nostrils or small sores appearing as a rule on the hind legs. Sometimes we find these small boils appearing on the body, breaking and discharging a thin sticky material which, like the discharges from the nostrils, seems to catch and hold the dirt, "gumming of the parts," as expressed by those with experience. A good many owners are always fearful that a discharge from the nostril is due to glanders. As a matter of fact in glanders the discharge is very slight and many times overlooked, or, as the owner says, animal has just a little cold; meaning he gauges the extent of a cold by the discharge: if very great, then it has a bad cold, if slight, a little cold.

A horse may discharge from a variety of causes, such as a sore throat, in which case it is profuse; as a result of distemper, a diseased tooth, in which case a bad odor exists.

In glanders it is again repeated, the discharge being slight, sometimes in advanced cases is accompanied by a hemorrhage. Any profuse hemorrhage from the nostrils should be looked upon with suspicion and promptly reported to the state authorities.

Navel or Joint Ill in foals is an infectious disease and causes the death of many foals. It is commonly supposed the infection is taken up through the navel, rapidly extending to the liver and thence getting

into the circulation, where the organisms are carried to the joints. The result is that the joints become swollen and filled with a chocolate colored, reddish brown fluid. The colt refuses to feed and remains down unable to rise. Vaccination by a veterinarian affords a remedy.

Here again prevention plays a prominent part. Mares before foaling should be given clean quarters which must be kept clean. Immediately colt is born an anti-septic dressing should be applied to the navel and kept in place by a bandage.

TETANUS OR LOCK-JAW

A disease seen more frequently in horses than in any other animal. In some horse barns where the disease is prevalent the slightest injury to any part of the body may result in lockjaw. The germ causing this disease seems to enjoy life for a long period of time in old barns, and it is a fact horse manure and dirt are its favorite lurking places.

The symptoms first observed are a stiffness of the neck; to use an old expression the animal stands with its nose "poked out." The tail is noticed to be elevated a little; elevating the head causes the eye to retract and as the disease advances we see violent spasms.

Animal should be immediately placed in roomy quarters by itself and the services of an expert veterinarian called.

The use of tetanic serum in the initial form gives fairly favorable results.

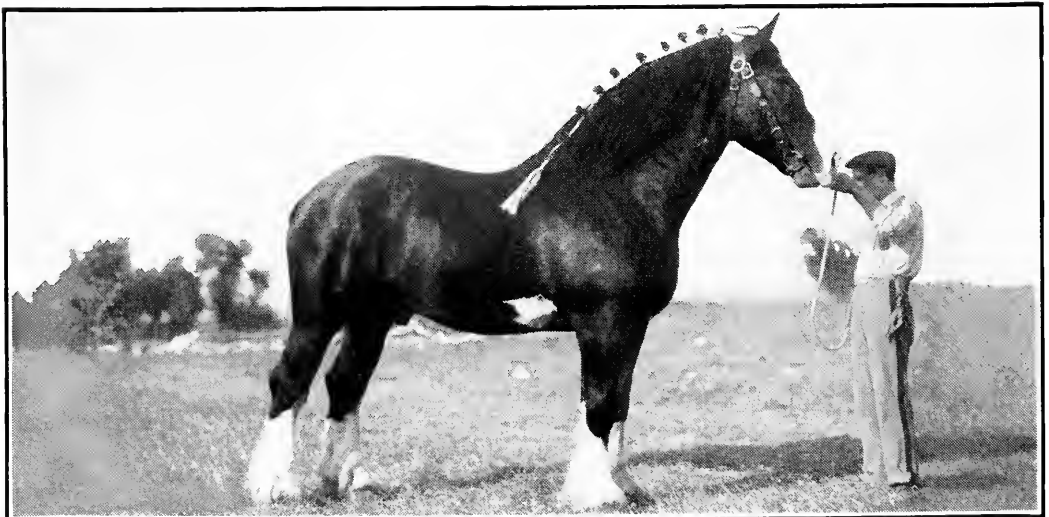

CHAMPION ENGLISH SHIRE STALLION "DAN PATCH," A FOUR-TIME PRIZE WINNER.
Truman's Stock Farm, Bushnell, Ill.

The SHIRE breed of draft horses come from England and for heavy draft it is unsurpassed. Stallions range from 1700 lbs. to the great size of 2400 lbs., the height running from 15 to 17 hands, mares less accordingly. Preferred color is bay or brown with white forehead and on legs. Numerous chestnuts, blacks and grays are found and long hair below knees and hocks is characteristic.

How to Tell the Age of a Horse



FRONT TEETH LOWER JAW, THREE YEARS
Two center permanent teeth up



SIDE VIEW FIVE-YEAR-OLD MOUTH



FRONT TEETH UPPER JAW TEN YEARS
Cups out of intermediate teeth

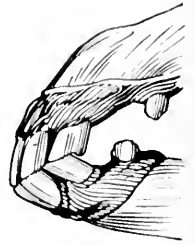

SIDE VIEW OF TWENTY-ONE YEAR-OLD MOUTH
Note sharp angle at which the teeth meet



FRONT TEETH LOWER JAW FOUR YEARS
Four center permanent teeth up



FRONT TEETH UPPER JAW ELEVEN YEARS
Cups all out



FRONT TEETH LOWER JAW FIVE YEARS
All permanent teeth up



FRONT TEETH LOWER JAW SEVEN YEARS
Cups out of intermediate teeth

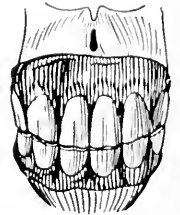

FRONT VIEW TWENTY-ONE YEAR-OLD MOUTH



FRONT TEETH LOWER JAW SIX YEARS
Cups out of center teeth



FRONT TEETH LOWER JAW EIGHT YEARS
Cups all out



FRONT TEETH UPPER JAW FIFTEEN YEARS
Teeth very triangular

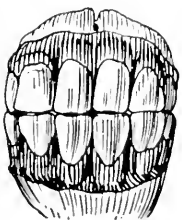

FRONT VIEW FIVE-YEAR-OLD MOUTH



FRONT TEETH UPPER JAW NINE YEARS
Cups out of center teeth



FRONT TEETH UPPER JAW TWENTY-ONE YEARS



FRONT TEETH UPPER JAW THIRTY YEARS OF AGE

Horses when full grown have forty teeth, twenty on each jaw, classed as follows: Six nippers, two canines, one at each side, and twelve molar teeth, six at each side.

Only the nippers or front teeth are considered in telling the age of a horse. The accompanying diagrams show the structure and appearance of these nipper

teeth at all ages. The wear on the nipper surfaces from five to eleven enable us to estimate the age.

It is difficult to tell the age of a horse past the eleventh year, and in practice the age is designated as being eleven past, or fifteen past, as the case may be. Just how much past cannot be accurately stated.

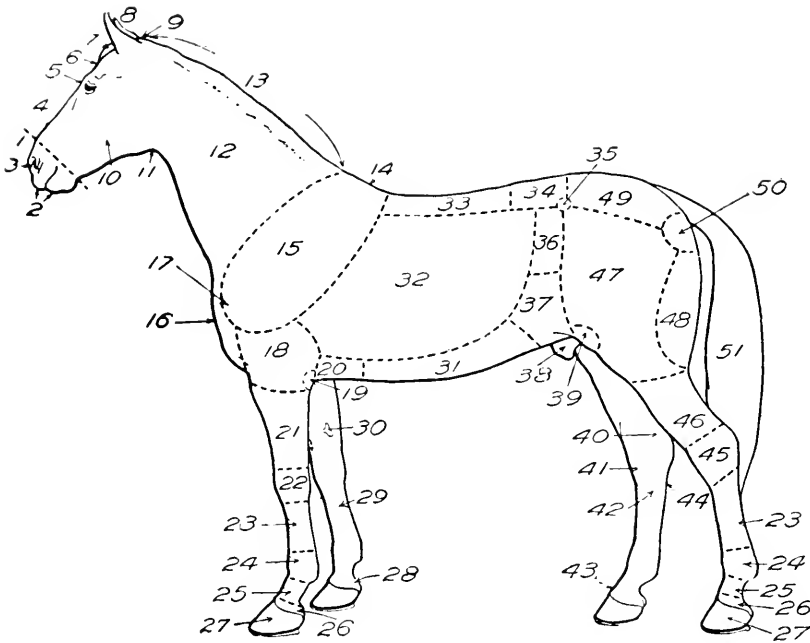

REGIONS OF THE HORSE

- | | | |
|------------------------|-----------------------|--------------------------|
| 1. Muzzle. | 18. Arm. | 35. Point of hip. |
| 2. Lips. | 19. Elbow. | 36. Coupling. |
| 3. Nostril. | 20. Fore flank. | 37. Hind flank. |
| 4. Face. | 21. Forearm. | 38. Sheath. |
| 5. Eye. | 22. Knee. | 39. Stifle joint. |
| 6. Forehead. | 23. Cannon. | 40. Seat of thoroughpin. |
| 7. Foretop. | 24. Fetlock joint. | 41. Seat of bog spavin. |
| 8. Ears. | 25. Pastern. | 42. Seat of bone spavin. |
| 9. Poll. | 26. Coronet. | 43. Seat of ringbone. |
| 10. Jaw. | 27. Hoof. | 44. Seat of curb. |
| 11. Throatlatch. | 28. Seat of sidebone. | 45. Hock. |
| 12. Neck. | 29. Seat of splint. | 46. Gaskin. |
| 13. Crest. | 30. Chestnut. | 47. Thigh. |
| 14. Withers. | 31. Abdomen. | 48. Quarter. |
| 15. Shoulder. | 32. Ribs. | 49. Croup. |
| 16. Breast. | 33. Back. | 50. Point of buttock. |
| 17. Point of shoulder. | 34. Loin. | 51. Tail. |

THE LENGTH OF INTESTINES AND CAPACITY OF STOMACHS

Animal	Capacity, Quarts		Total	Length, Feet Intestines.
	Stomach	Intestines		
Horse	19.0	204.8	223.8	98.1
Cow	266.9	109.8	376.7	189.2
Sheep	31.3	15.4	46.7	107.3
Hogs	8.5	20.5	29.0	71.1

It requires from three to four days for food to pass through the digestive tract of farm animals.

DIGESTIVE ORGANS

The stomach and intestines of farm animals differ widely as to capacity, size and structure. The stomach of the horse and pig is a single sack and has not nearly the capacity of the cow or sheep which have four

stomachs; namely the paunch, honey-comb, many plies and rennet, the food first being stored in the paunch, rechewed—chewing the cud—and then returned to the other stomachs.

DISTEMPER OF COLTS

Sometimes called stranglers. It appears in young horses at from one to five years of age; one attack as a rule confers immunity.

Symptoms usually start with more or less fever, some stiffness of the neck, followed by the swelling of the gland between the lower jaws. About this time is noticed some slight discharge from the nostrils which increases, becomes thick and of a creamy color.

The swelling under the jaw increases in size and becomes hot and painful. The skin in course of time softens and the abscess breaks, at once relieving the animal and recovery immediately begins.

Occasionally an abscess may form in the angle back of the jaw and below the ear, in which case the services of a veterinarian must be called to open up the abscess. This region is a dangerous place to operate on for any but an expert. The course of the disease runs two or three weeks, and like other diseases complications sometimes arise.

Treatment is plenty of air, cold water and soft feed in the nature of boiled oats or bran mashes given in small quantities as hot as can be made.

INFLUENZA

Known also as Pink Eye, Shipping Fever, Stock Yards Fever. This is a much more serious disease than the one previously mentioned, as it affects both young and old, and many times is complicated with pneumonia, pleurisy and a blood complication.

Symptoms are loss of appetite, high fever, and an extremely weak condition, being very similar to the "grippe" in man.

The disease spreads rapidly and runs its



A GOOD OLD FAMILY HORSE

From the Carriage, Driving and Coach type of horses comes that patient and hard working friend, the "good old family horse" which the automobile is rapidly supplanting.

course in about a week unless some complication makes its appearance.

Treatment is, in the main, careful feeding with plenty of fresh air. Affected animals should be placed where they can get all the fresh air possible, and drafts avoided. If confined in a barn with poor ventilation, recovery is retarded and complications may set in.

Cold water should be given freely and a teaspoonful of salt petre can be given in the drinking water three times a day.

Animals should be very closely watched for the appearance of any additional symptoms, indicating complications, in which event the services of a veterinarian should at once be called.

DISINFECTING BARN AND PREMISES

The first step to be taken is open up doors and windows, then remove all litter, manure and other refuse; the ceilings, mangers, and stalls should be swept clean. A disinfectant (any of the coal tar preparations) is to be mixed in the proportion of six ounces to each gallon of water. The mangers and feed boxes are to be scrubbed, followed by the sprinkling of the floors and stalls. This can be done with the aid of an old broom or a cheap spraying machine can be purchased from almost any hardware store. After the solution has dried all woodwork should be whitewashed, adding about four ounces of chloride of lime to each gallon of whitewash. This can also be applied with a sprayer, and is a very quick and thorough way of doing the work.

Pens and lots are first cleaned of all litter and the ground and fences sprayed as directed, followed by the whitewashing of posts and frames.

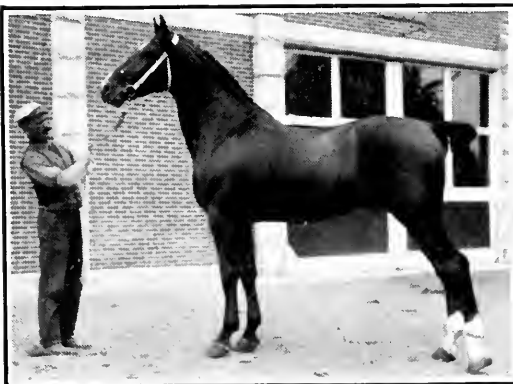

FRENCH COACH STALLION

This type originated in France. Weight varies in Stallions from 1100 lbs. to 1400 lbs., mares 200 lbs. lighter. Height ranges 15 to 16½ hands. Bays and browns predominate, black and chestnuts infrequent.



SWINE

Sore mouths in young pigs. This condition is frequently met with and is called to the attention of the owner by the attempt of the young pigs to suckle. The soreness of the mouth prevents them from taking nourishment and emaciation and death follows. An examination of the mouth reveals the margins of the gums swollen with raw surfaces covered by a dead tissue.

The germ which is to blame, is found in the digestive tract of swine and probably in the soil as a result of contamination from the feces.

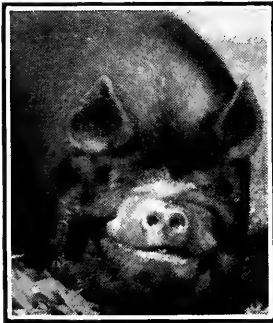

"MASTERPIECE"
A Champion Berkshire Boar.

The udder of the mother becomes dirty as a result of contact with the ground and the infection is taken into the mouths of the young pigs when feeding.

Treatment consists in the application of a weak solution of blue vitriol applied with a swab to the sore parts. The udder of the mother should be washed with a disinfectant, and mother and young removed to clean, dry quarters.

Hog pens and enclosures should be kept clean and disinfected at all times. (See hog cholera.)

Vomiting is quite frequently seen in swine and may be due to over feeding, hog cholera or a symptom of disease, poisoning from salt, caustic potash.

Air bubbles around intestines. This condition is frequently seen in hogs slaughtered on owners' premises and causes more or less alarm, hence it will be touched upon. These small air bubbles present a grapy-like crystal appearance. The exact cause is not known. Carcasses of animals so affected are perfectly good for food purposes.

Heat stroke (see under "Horses" for treatment).

THUMPS

Spasm of the midriff common in young pigs. They will jerk violently at the flanks, sometimes quite rapidly, slowing down only to start off again with greater energy. It is often observed in young pigs well fed and have not had sufficient exercise. Pigs confined to small pens become sluggish, hence it is advisable to force them to exercise, otherwise thumps result.

Rheumatism. Complaints are made of this trouble. It is possible if swine are kept in damp quarters. Occasionally the joints are swollen and animal exhibits more or less lameness. Change to dry, warm quarters.

Rickets. In this case animals go down behind, unable to use their legs. A condition common in young thrifty hogs, due to a lack of lime in the bones.

There is little use in prolonging the life of animals so affected. It is better to slaughter them at once as the carcass can be used for food purposes. To delay action means loss of carcass, as animal may bruise itself and develop fever, in which event it would be unfit for food.



"HIGH STYLE." A Famous Boar.

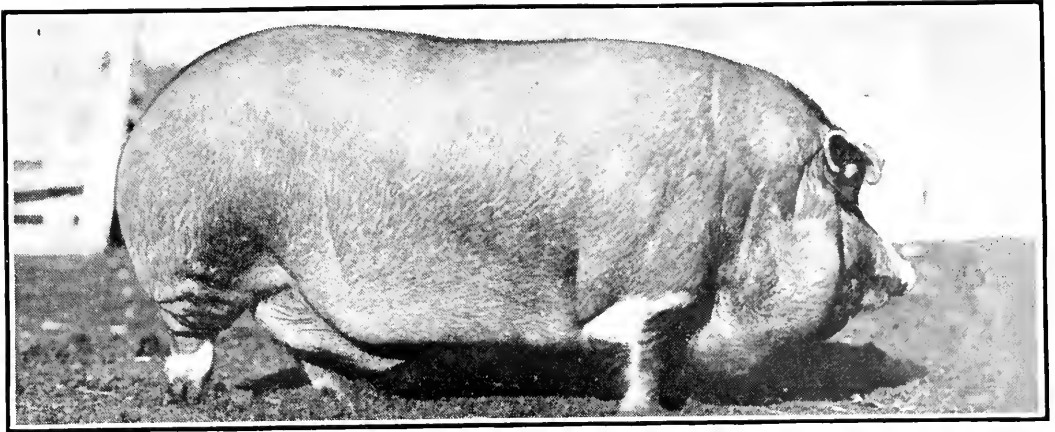

"HIGH STYLE"—A \$5,000 Poland China Boar.

This breed originated in Southwestern Ohio, matures early, takes on fat economically and represents the extreme development of the lard production type. Size is classed as middle weight, black with white markings, drooping ears, face straight.

RESPIRATORY TROUBLES

The only disease which will be described under this heading is Verminous Bronchitis.

Verminous Bronchitis is quite common in young pigs in the summer and early fall and produces considerable alarm, because of the fact that all the young pigs may be coughing. Frequently we find young animals cough so hard that the spleen ruptures and death of course follows. It is quite common to see young pigs, in good condition, stand and cough for several moments. The cause is due to a parasite known as the lung worm. The eggs gain entrance in all probability through the food or water supply. It is likely the back of the throat is the first stopping point of the young worms, from which point they find their way into the bronchial tubes. Just how long a period elapses between the time they are taken up until evidence of their existence is seen it

is impossible to say. Undoubtedly the incubation period is about six weeks.

Treatment is difficult and about the only rational method of treatment is confining animals to an air-tight place and burning sulphur until the pigs are overcome, when they can be dragged into the fresh air and revived.

Prevention plays an important part in this disease, as in many other parasitic troubles. Clean quarters, clean feed and clean water are necessary. Hog run should be changed every other year and the old yards plowed up.

Lime should be freely used in the pens, and hog wallows should be provided in the summer, filled with a disinfectant. A concrete hog wallow can be built with very little expense. A cheap disinfectant solution can be used, which will well repay the owner, as it prevents mange, lice and other parasites from preying upon the swine.



POLAND CHINA SOWS

INFECTIOUS DISEASES OF SWINE

Hog Cholera

We find but two diseases that are apt to cause a high mortality in pigs. These are hog cholera and necrobacillosis. Hog cholera is familiar to every swine raiser in the corn belt section. No attempt will therefore be made to describe the symptoms.

rapid course, causing death in a short time; in other outbreaks it assumes a slow chronic course. It is a difficult matter to form any opinion as to the manner swine acquire the disease. In many cases it is due to the introduction on the premises of a diseased animal; or by persons or dogs carrying the infection. Only the smallest particle of matter is needed to convey the germ of this

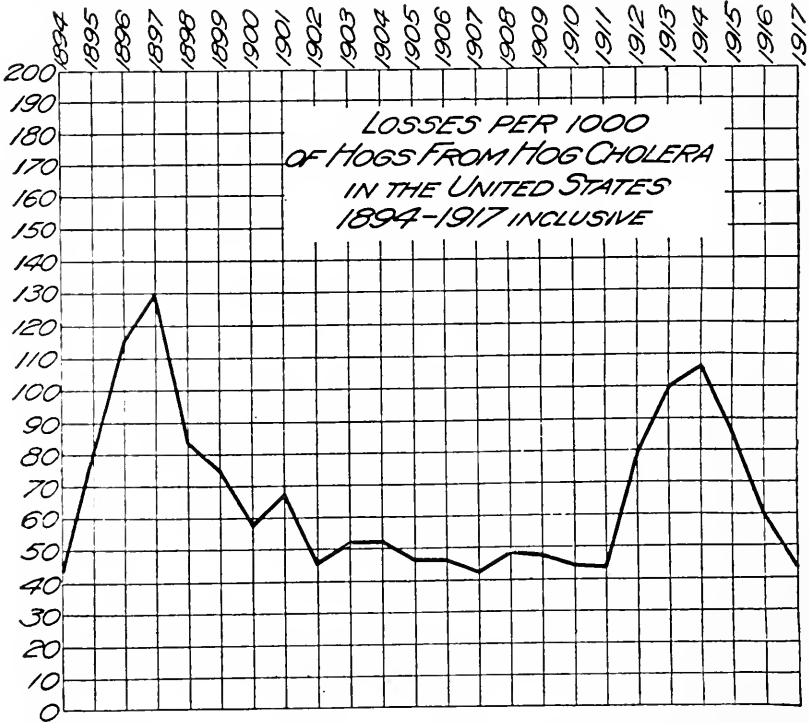

Like all epidemics, we have severe outbreaks every so often, at which time the disease seems to spread over the entire country causing immense losses, gradually dying out and remaining dormant for three or four years.

In some outbreaks the disease runs a very

disease. Flies have a good deal to do with its spread, much more so than any one imagines.

Treatment. Vaccination is now recognized as being the most efficient. Large doses of anti-hog cholera serum are given the pigs with excellent results.

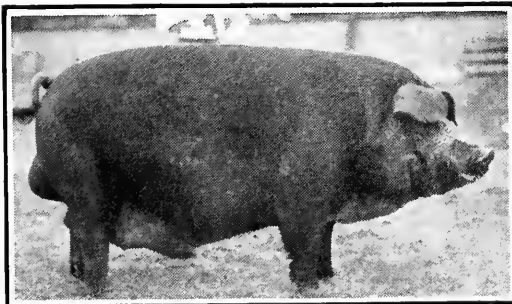

DUROC JERSEY BOAR

Native of United States; medium size, red, ears droop, face straight; sows are prolific. This type noted for fat production.



YORKSHIRE BOAR (Bacon Type)

Native of England, medium size. The color is white, ears erect and face greatly dished. Noted for fattening qualities.

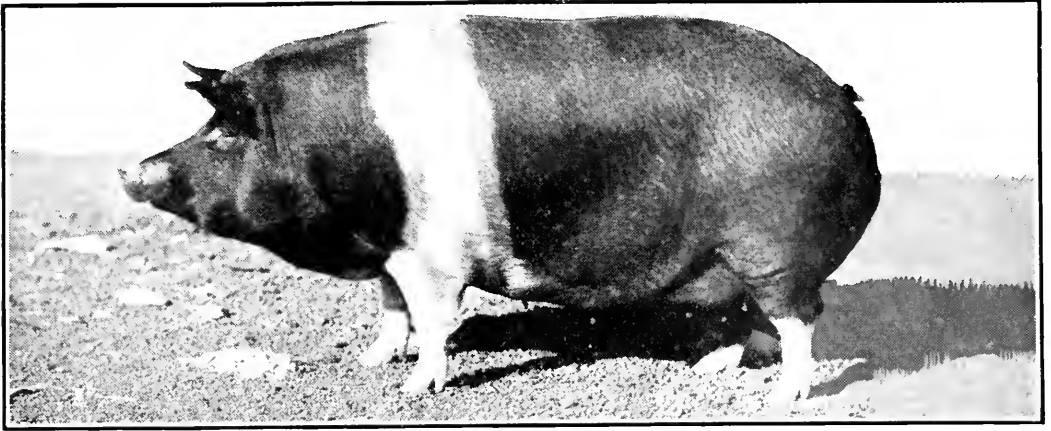

PRIZE WINNING HAMPSHIRE SOW

*HAMPSHIRE*s, native of United States. Like Poland China type, noted for early maturing and economic fattening. Middle weights. Black with white belt around body. Breed in demand by packers.

A great many favor the immunization of hogs by the serum-virus method. Much can be said for and against it. It must be admitted by all familiar with its use that in some cases it has proved most valuable and in others it has proved disastrous. Until such time as the serum and virus can be standardized, caution in its use is necessary.

Much can be done in preventing the disease. For many years we have recommended the constant disinfection of swine in the summer months, and no more effective way can be found than in the building of cement

hog wallows which can be filled with a non-poisonous disinfectant solution.

Special pens should be built into which hogs should be allowed only at feeding time.

These pens, with feed troughs, should be kept clean and disinfected daily.

Owners must keep in mind that excretions are infectious. By excretions is meant tears, discharge from the nostrils, urine and feces. When hog cholera is in the neighborhood dogs should be kept upon the premises and not allowed to run at large. Visitors should be kept from all hog enclosures.

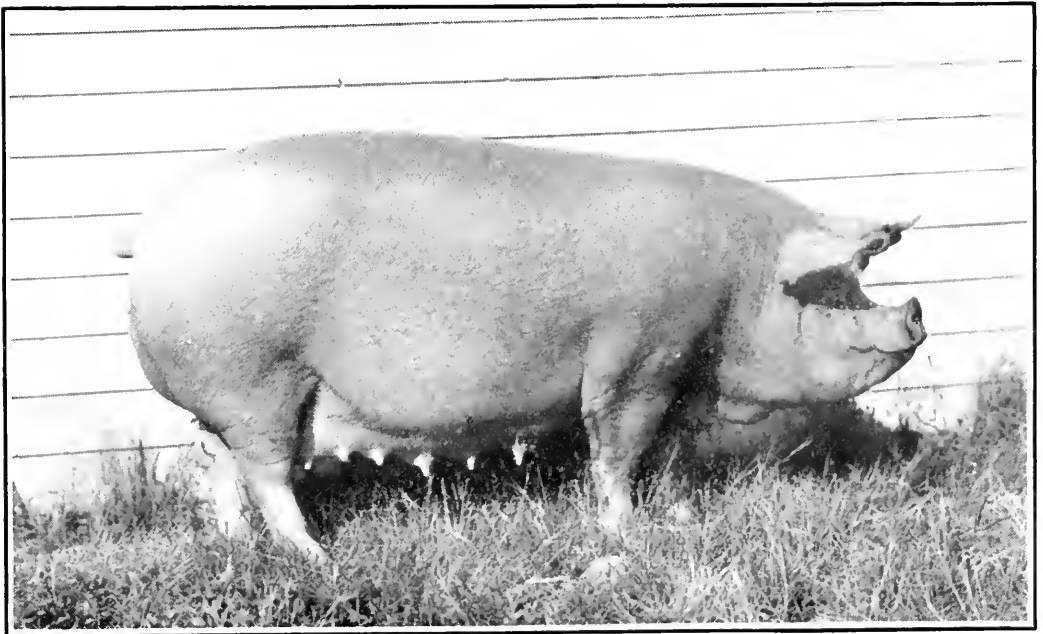

1ST PRIZE YORKSHIRE SOW, Minnesota State Fair 1917

The Large Yorkshires are bacon type, developed in England. Meat excellent, fat and lean well mixed. Size classed as large. Excellent breeder, maturing late. White color, ears droop forward, dished face.

NECROBACILLOSIS

This disease is very frequently mistaken for the chronic form of hog cholera. In hog cholera we have a peculiar condition of the kidneys, sometimes called turkey egg kidney, indicating it is spotted like a turkey egg. The spots in the kidney are not much larger than a pin point and bright red. These red spots indicate a rupture of a very small artery which has been plugged with germs. In necrobacillosis this condition of the kidney is absent, and we have, if the intestines are examined closely, a thickening of the outside wall, on which are small white patches of dead tissue. In some cases we are able to detach or peel off a false membrane from the wall. Hogs which linger along frequently lose patches of the skin and the ear or tail may possibly slough off.

Vaccination in such cases does no good and we must resort to other treatment in the form of internal antiseptics, such as powdered hyposulphite of soda, a tablespoonful to hogs weighing about one hundred pounds. As this medicine has little taste it can be given at each feed in anything animal will take.

Prevention. The cleaning of pens and troughs should be practiced, followed by disinfection. Keep in mind the germ is a natural inhabitant of the intestines of pigs, consequently floors of hog pens and enclosures are more or less infected. This same organism causes sore mouths in sucking pigs.

TUBERCULOSIS

This disease is becoming alarmingly prevalent among hogs, and has increased in proportion to the creamery industry. There is little doubt but infection is through the medium of skim milk. When farmers feed skim milk or other by-products obtained from creameries or cheese factories, it is policy to pasteurize, or partially cook it.

The practice also prevails of letting hogs feed upon the carcasses of dead animals. In the case of a cow dying from tuberculosis, it can be readily seen how easy it is for the animals to become infected. It is astonishing

how rapidly the disease progresses in swine, invading almost every vital organ of the body, and rendering the carcass absolutely valueless for food purposes.

Symptoms in hogs are not very pronounced. Experts can sometimes diagnose its existence in a herd by observing if the glands of the

throat are swollen. These swellings can be detected by facing the animal, when it will be seen the neck in the space below the ears and back of the jaws bulges out, due to the affected glands. Once the disease is established the entire herd should be disposed of for slaughter, subject to inspection.

New quarters should then be provided for restocking with healthy animals. The home herd of cattle should be tuberculin tested and precautions taken, as previously suggested, to boil all skim milk obtained from outside sources.



A PRIZE CHESTER BARROW

Chesters originated in New York State. Small, white ears erect, face scooped, half bacon and half lard type; slow maturing, good breeders.



CHESTER BOAR



TAMWORTH SOW—(Bacon Type)

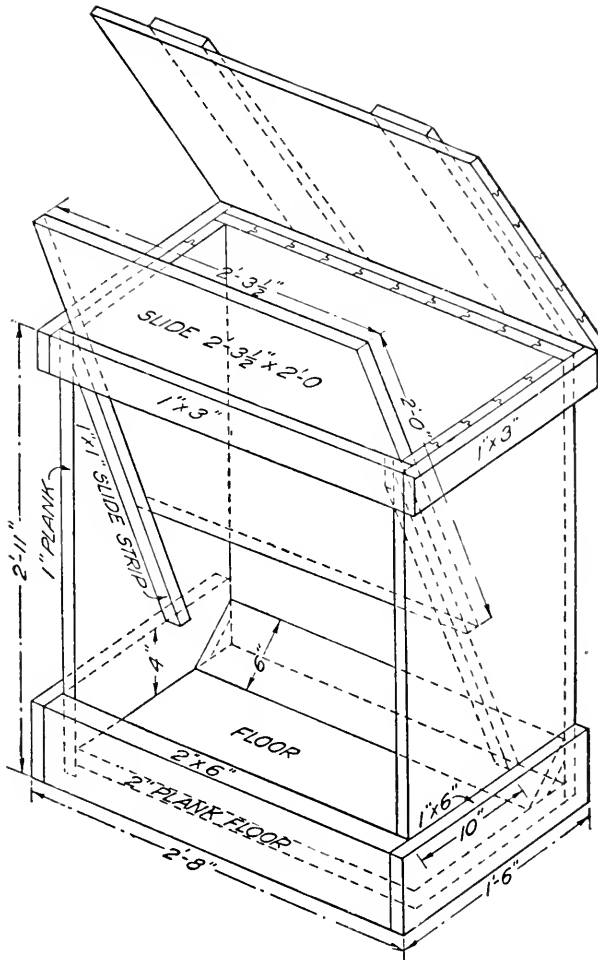

SELF-FEEDER FOR SUCKLING PIGS USED AT THE GOVERNMENT EXPERIMENT FARM, BELTSVILLE, MD.

The self-feeder shown is one used at the Government Experiment Farm at Beltsville, Maryland. This self-feeder is very handy for suckling pigs while they are with their mother.

A self-feeder of this type can be placed in the corner of the lot in which the sow and pigs are kept, placing a few boards across the corner from one fence to another to keep out the sow. Allow space enough under the bottom board to permit the young pigs to crawl under. They form a creep for the young pigs, which can learn to eat very readily without being disturbed.

Hogs in the wild state were self-fed animals, living upon such feeds as would satisfy their appetites, and under domestication they seem to thrive best when fed by the

same principle. The marked success of the self-feeding system of hog raising is largely due to the fact that they may eat an abundance of those feeds which will nourish them to the best advantage.

Cracked corn, or corn meal and tankage mixed in proportion of 10 to 1, is an elegant ration. As the pigs grow older whole corn can be substituted for cracked corn or corn meal. The quickest, the easiest and the most economical method of fattening pigs is through the use of the self-feeder.

The self-feeder should be built upon a pair of skids or runners to prevent rotting of the floor and to facilitate moving. By using the best grade of lumber and applying yearly a coat of paint a well constructed self-feeder will give service through a number of years.

PARASITES

We find five or six varieties of worms affecting swine, one of which has already been described under bronchitis. The others infest the stomach and intestinal canal.

Probably the most harmful of parasites, because it is communicated to man, with oftentimes fatal results, is that known as *Trechinella Spiralis*. This parasite may affect practically all meat-eating animals. If the flesh is infested the larvae are released and find their way to the muscles where they become lodged. During their migration from the stomach they cause severe rheumatic pains. A man eating infested pork which has not been properly cooked becomes affected and in many cases death follows.

Pigs usually acquire the disease from eating rats, or the flesh of another pig which has died as a result of harboring the worm.

The symptoms are somewhat vague, but we suspect the existence of these worms when pigs show severe pains. They apparently squeal and are uneasy for no cause, frequently exhibiting pain when touched or moved around. The parasite is not visible to the naked eye, hence its presence may not be diagnosed unless a search of the muscles are made for the worm with the aid of a microscope.

Thorough cooking destroys the worm, which therefore suggests the method of prevention in the human.

Another parasite which infests man is also acquired from the pig. In the pig we have the immature worm, known as cysticercus or measy pork. Its presence is manifested by small milky like bladders about the size of tapioca, which may be seen

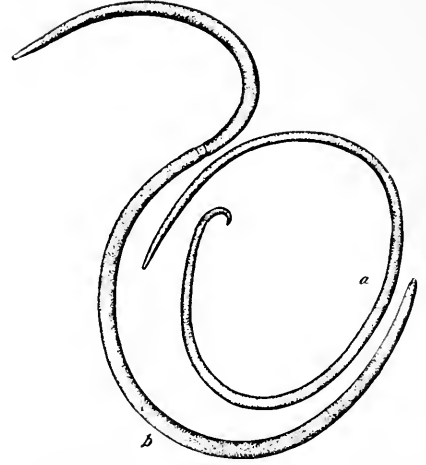

THE COMMON ROUND WORM OF SWINE
(A *Scaris Suum*) a, Male; b, Female.

on the heart and sometimes in the muscles. These small bladders contain the head of the parasite. When the partly cooked meat is eaten by man the juices of the stomach release the worm which immediately begins to grow, adding a small segment at a time to its body until it reaches a considerable length.

Man is the host of two tapeworms, the one just mentioned acquired from eating pork and the other from cattle. The manifestations in the pig are similar to those of cattle and the life history is the same. Cattle and swine take up the eggs of the tapeworm passed by man. The larvae find their resting place in the animals where they remain immature and can only attain their full growth when taken into the system of human beings. Thorough cooking of all meats is essential to human health.

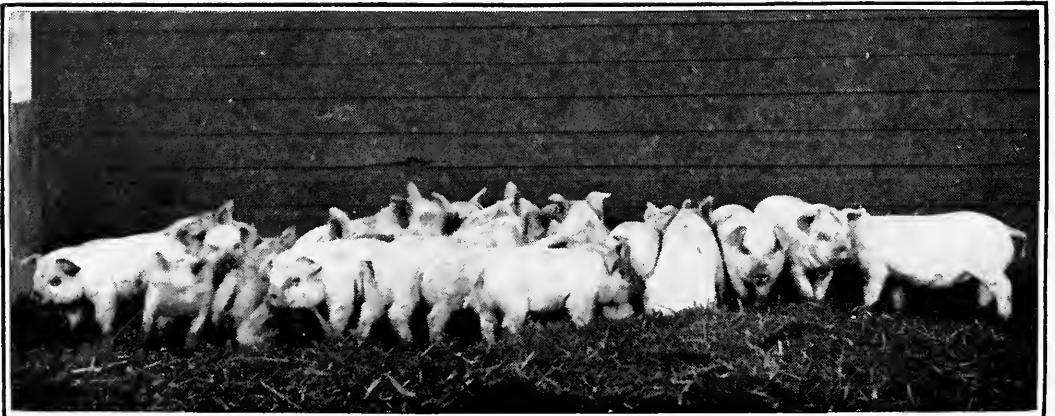

A GROUP OF CHESTER WHITE PIGS



CHESTER WHITE SOW AND PIGS

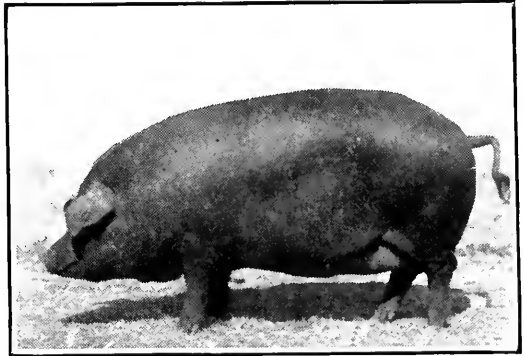

DUROC SOW

EPILEPSY OR FITS

Many owners complain of their hogs having fits. They state animals seem all right until they begin to feed. After taking a few mouthfuls they squeal and tumble over, shake and tremble, lie down a short time and then get up. In the majority of cases the cause is due to indigestion, which creates some functional disturbance, bringing about the train of symptoms mentioned. When animals are noticed to show this condition they should be separated and given about a tablespoonful of Epsom salts in their feed. A fifty-pound hog can be given the amount mentioned and the dose can be graded for heavier hogs. Light feeding should follow and animals given plenty of exercise. This treatment should reduce the frequency of this malady until it finally disappears.

HEMORRHOIDS, PILES

This is another condition which is often met with. It is usually caused by feeding shorts, and again when animals are given only one kind of feed. Laxatives and mixed feeding is indicated.

LICE

This parasite in swine is quite large and readily seen. It is advisable to keep swine free from lice at all ages, for when numerous they tend to retard fattening. Where a large number of hogs are kept a dipping tank or hog wallow should be provided. In case this cannot be done the use of kerosene diluted one-half with warm, soapy water may be used. Pens must, of course, be cleaned and sprayed with some cheap disinfectant. This should be done thoroughly.

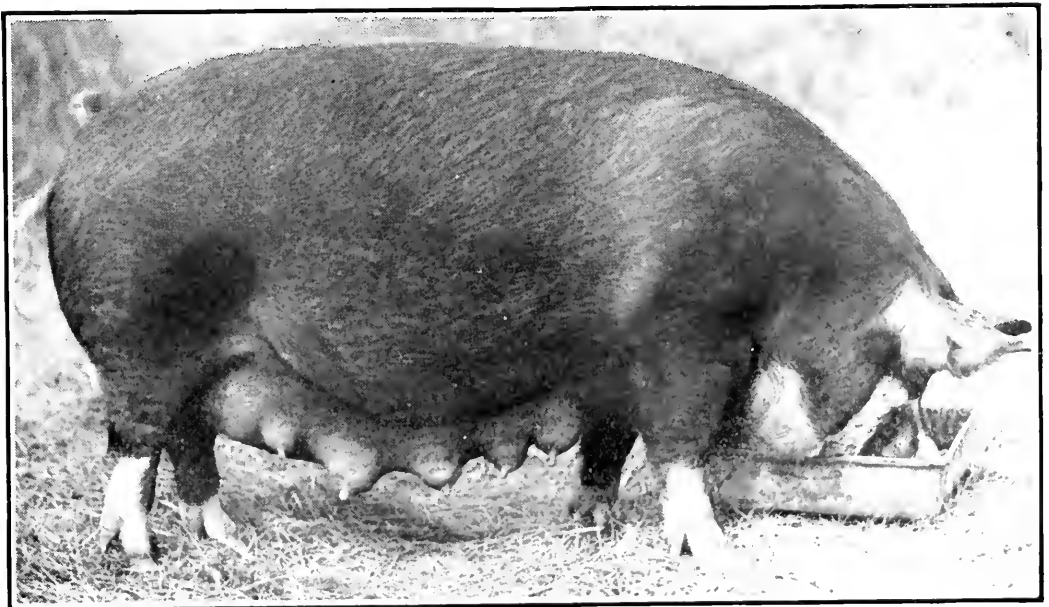

1ST PRIZE—BERKSHIRE SOW — International Live Stock Exposition.



SHEEP

THE common impression prevails that any one can successfully raise and breed sheep. No other animals on the farm require less attention, or suffer less from disease than do sheep. Like anything else, some practical experience is necessary to be successful. It is suggested those intending going into sheep raising should begin with a limited number; watch their habits and peculiarities and as your observations increase extend the flock.

The one great drawback and most discouraging feature to the flock master is losses from dogs. Until such time as the actions of this pest is controlled more or less loss will be experienced. In some states owners are authorized to shoot any dog seen worrying sheep. The death of a dog, however, does not compensate the sheep owner for five or six dead sheep. More protection should be afforded sheep owners by placing the burden of loss or damage on the dog owner.

Sickness in sheep is quickly recognized by the experienced. Animal will lag behind, its head lowered and ears lopped.

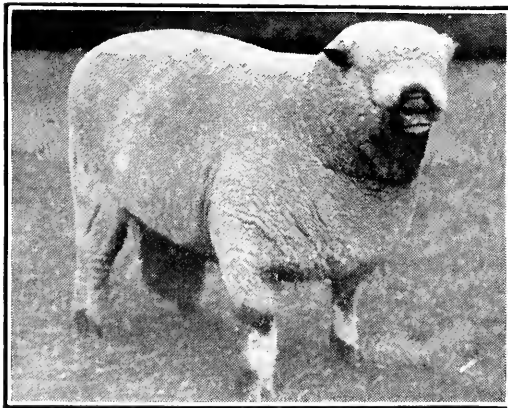

GRAND CHAMPION SHROPSHIRE RAM
International Exposition 1916

THE SHROPSHIRE DOWN Variety of mutton sheep came from Shropshire, England. Similar, but larger than Southdown; rams weigh 225 lbs., ewes 150 lbs. Of early maturing qualities, excellent mutton. Excel Southdowns as wool producers—bearing 5 to 10 lbs. medium length wool. Very popular breed in United States.

It might be asked what breed of sheep is best adapted to the corn belt section? The writer from experience believes the South-down or Shropshires are perhaps the best suited to the needs of the small farmer.

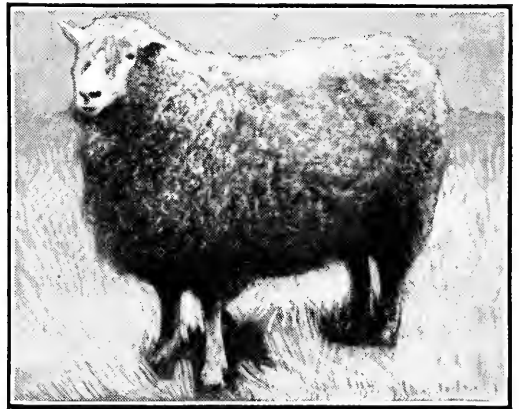

A CHOICE COTSWOLD EWE

THE COTSWOLD breed is noted for both mutton and wool. Native of England. Large breed; rams weigh 250 lbs., ewes over 200 lbs. Wool 10 to 14 inches long and 6 to 10 lbs. weight, a popular breed in United States.

Sheep suffer from only one malignant infectious disease, known to the profession as **hemorrhagic septicaemia**. Happily, outbreaks are few and far between, and then as a rule only in sheep shipped long journeys and which pass through public stock yards.

Symptoms are very few, if any are noticed. The owner's attention is only directed to it by the sudden death of the sheep, which may show a frothy, bloody discharge from the nostrils.

If sheep are opened we see claret colored spots on the internal organs. Close observation of the other sheep will reveal some with the ears hanging down, instead of being held at right angles. They may be apart by themselves, and breathing rapidly.

Treatment. In recent years there has been developed a vaccine which proves very efficacious in outbreaks of this disease among cattle, and reports on its use in sheep indicate it is of great value in controlling and limiting losses in sheep.

PARASITES

or worms, are the greatest menace the flock master meets with. Careful attention to the feed and water supply will overcome this.

Stomach Worm. The most important parasite is that known as the stomach worm. It is a small hairlike worm about three-quarters of an inch in length, the male being a little shorter. The worm is a true blood

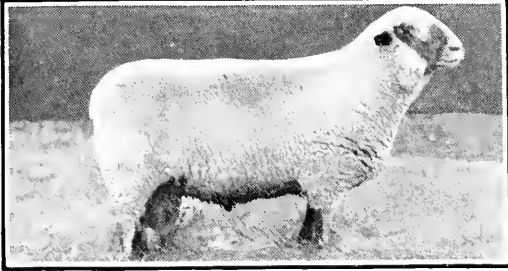

A CHAMPION HAMPSHIRE RAM

HAMPSHIRE DOWN BREED, native of England—mutton type—large size—rams about 240 lbs., ewes 180 to 200 lbs. Excellent mutton qualities—wool yield, coarse, inferior to Shropshire or Southdown, being about 7 lbs.

sucker and frequently attaches itself firmly to the walls of the stomach.

Symptoms in the young sheep are at first difficult to determine. As the worms increase in numbers, we find that the lambs will have dropsical swellings along the abdomen and brisket. This dropsical condition is due to the anemia which follows the heavy infestation of any variety of worms which sustain themselves by blood sucking. On opening the stomach of a sheep, little at first will be seen, but by closely watching the contents of the stomach and holding a small portion of the contents level with the eye, millions of living worms may be seen. In some cases we have a seething mass in continual motion.

The eggs are passed in the feces by the older sheep. Hatching in a few days they

crawl up the grass blades while they are wet from the dew or rain, and are taken up into the stomach by the sheep as they feed. Knowing their habits we can prevent infestation by keeping the sheep off pastures until the grass is dry.

Verminous Bronchitis. Another condition due to infested pastures. The worm penetrates into the air passages (bronchial tubes) causing bronchitis. The life history of this worm is very similar to that of the stomach worm.

Symptoms usually make their appearance during July and August, and as in calves and pigs we have a peculiar cough that is almost diagnostic.

In examining for this worm the bronchial tubes should be split clear to their terminations and somewhere toward their terminals the worms will be found.

Treatment is entirely unsatisfactory, and so preventive measures are necessary. These consist of keeping animals from the pasture while the dew is on the grass. Sheep pastures should be rotated two or three times during the season. When it is known a



PRIZE DORSET RAMS—ILLINOIS STATE FAIR

HORNED DORSETS OF ENGLAND. Excellent wool and mutton type qualities. Unexcelled breeding qualities—hardy grazers. Rams weigh 200 lbs., ewes 160 lbs., shearing 5 to 10 lbs. wool.

flock is affected with worms pastures should be plowed up. In case this cannot be done they should be burned over in the spring.



WHERE PEACE AND QUIET REIGN

GRUB IN THE HEAD

This condition is met with in the Spring of the year. Three or four of the flock may die as a result.

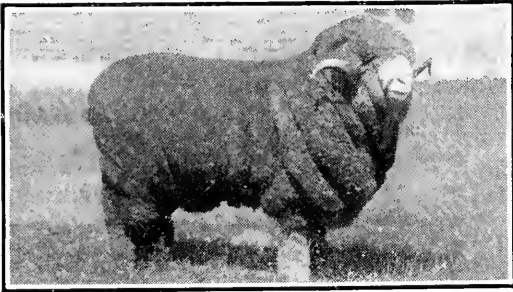

RAMBOUILLET RAM

The *RAMBOUILLET* breed fine wool sheep, native of France. Rams weigh 150 to 225 lbs., ewes 125 to 175 lbs. Noted for light, fine fleece, shearing 10 to 20 lbs., ewes 8 to 12 lbs.

The grub is a specie of bot-fly. In the hot summer months, the mature fly deposits its larvae on the nostrils of sheep. Provided with two hooks, they gradually work up into the cavities of the head. There they pass their larval stage. At the proper time they lose their hold and are sneezed out to the ground into which they burrow and in about two weeks emerge as a full grown fly.

Symptoms are somewhat vague. We suspect grubs when sheep are seen to be affected in the early spring months with severe catarrh, becoming stupid in their actions.

Treatment is of little account and preventive measures must be instituted. These consist of keeping the nostrils smeared with Stockholm tar during July and August. In addition the ground where sheep rest in the middle of the day should be plowed up, and animals allowed the use of darkened sheds.

Foot Rot is perhaps the next disease of importance that confronts the sheep raiser. It is more frequently found where sheep are permitted to run on low, swampy land. Occasionally we experience outbreaks where this condition does not prevail. The disease is another form of necrobacillosis which has been mentioned under swine diseases. The same germ is responsible for lip and leg ulceration and ulcerative vaginitis. These two latter conditions seem to

prevail only in the range country, while foot rot is comparatively unknown on the ranges but is common in other sections. It is a true infectious disease affecting sheep either in the front or hind feet, particularly between the claws. As the disease advances it extends up to the joints causing a swelling just above the hoof and most intense pain. It is distinguished quite easily by the lameness and offensive odor. An examination of the foot reveals the pus, which is of a whitish nature and sometimes small holes are seen in the upper and middle surface between the toes.

Treatment consists of running the sheep through a foot bath, containing some disinfectant.

A trough about a foot wide and twenty-four feet in length and of sufficient depth so that when the sheep are driven through the solution will be about two inches above the hoof.

Blue stone is perhaps the best to use, dissolving about four ounces in a gallon of water. A trough that will hold about twenty gallons would take five pounds of blue stone. The foot bath should be repeated every day for a week.

The same treatment, with a little stronger solution, can be applied to cattle which are affected with this same condition and

this will be found very beneficial.



SOUTHDOWN EWE 1st. Prize Minn. State Fair.

The *SOUTHDOWN* breed, mutton type, native of England. Noted for early maturing and delicious mutton. Rams weigh 175 lbs. ewes 135 lbs. Low wool yield, 4 to 8 lbs.

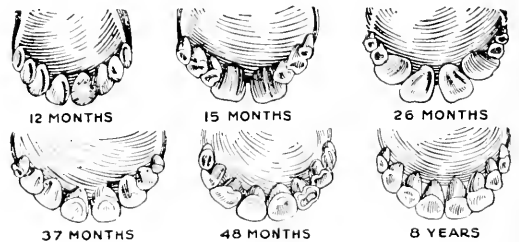

SHEEP'S TEETH ACCORDING TO AGE

Sheep have two sets of teeth like cattle—temporary or milk teeth—later, permanent teeth. Like cattle, sheep have eight teeth only in lower jaw, operating against a cartilaginous pad in upper jaw. Milk teeth are peg-like, the middle pair are replaced at about 15 months by permanent teeth; succeeding pairs appearing at about eleven month intervals.

After fourth year all permanent teeth are in wear. As animal ages teeth narrow. By eighth year much space appears between; teeth become discolored and with age drop out one by one.

Other general considerations in telling age of sheep are, of course, size up to one year. In old animals the poll is more pronounced; the hollows above the eyes deeper and the sides of the face are more depressed.

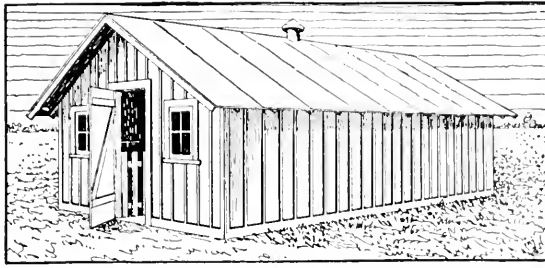

CLOSED SHEEP SHED—16x24 Feet

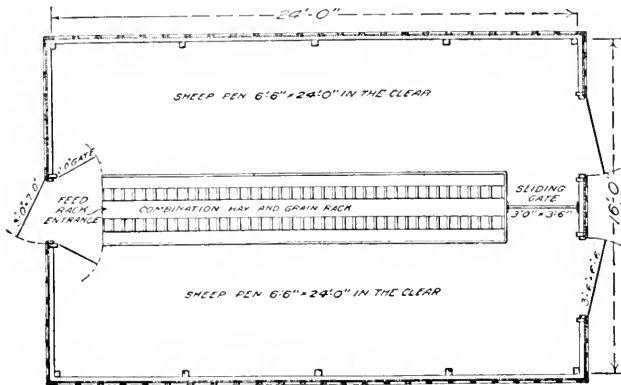

FLOOR PLAN OF CLOSED SHEEP SHED

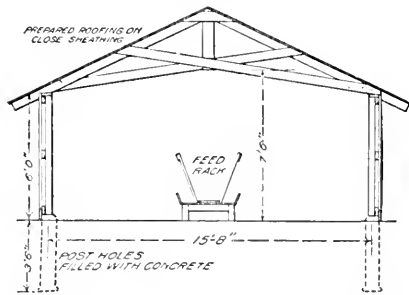

CROSS SECTION OF CLOSED SHEEP SHED

A CLOSED SHEEP SHED

Above cuts show a simple type of closed sheep shed which is especially adapted for farms on which the main barn has large feed capacity, but not sufficient floor space for live stock. Allowing twelve square feet of floor space per animal, this shed will hold twenty-six sheep, which gives a space at the rack of almost seventeen inches each. The feeding should be done entirely from walk-way in the center so as to avoid disturbing the sheep. The large door at the end of the rack is intended for taking in feed, which must be stored in another building. The windows of this shed should hang on center pivots to permit entrance of air through the full size window. Doors used by sheep may

be made in two parts, opening outward independently. The upper half should be hinged at its top and counter balanced by a weight connected to it by a light wire cable passing through a pulley at the side of the shed and another on the eave. A stay rod is needed to hold the door firmly when partly open. The doors, windows and adjusted roof ventilator will always furnish good ventilation. This shed affords good protection for sheep under any conditions and may be used for winter lambing if twenty feet wide instead of sixteen, so that as many detachable lambing pens as needed may be set up next the wall and still leave room at rack for other ewes. Estimated cost of this shed is about \$150.

SCAB

This disease, due to a true parasite, is by no means prevalent in this country. Unfortunately, sheep infected with this mite are sometimes imported into the flock.

This mite is exceedingly small and is best seen through a low power microscope. The mite irritates the skin, setting up an inflammation which causes an intense itching resulting in consequent rubbing and a great

loss of wool. The constant itching prevents the animal from feeding, as a result of which the health soon becomes impaired and death follows. The wool comes out in patches, leaving a scaly, parchmentlike condition of the skin. Sheep frequently lose their wool in patches by being confined in warm quarters, but in

this case the skin is clean and pliable.

Any suspicion of its existence, especially when new animals have lately been introduced into the flock, should at once be reported to the state authorities.

Other ailments to which the domestic animal is liable such as lung and intestinal troubles, do not seem to be as prevalent in sheep.

Sheep should at all times have access to clean, cold water and plenty of it. Change the water in their drinking troughs every day. In winter when snow is on the ground they rarely drink, their thirst being satisfied with snow.

Sheep thrive best on upland hay and a small quantity of oats can be given the breeding ewes. At lambing time, ewes should be watched very closely, as it seems a change of weather generally brings some

lambs, that without proper attention would perish. The udder should be examined to see that the teats are not clogged with wax.

The winter quarters should not be warm; in fact, about all that is necessary is shelter.

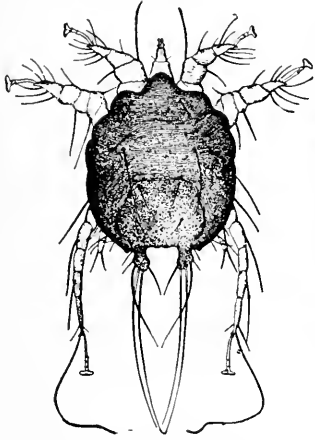

SHEEP SCAB MITE
Greatly enlarged
(Salmon & Stiles 1898)

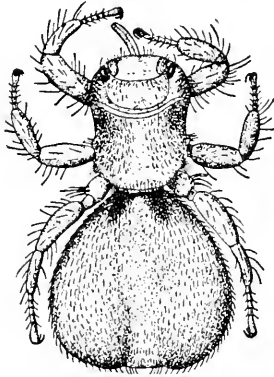

SHEEP TICK
Dorsal view—enlarged
(Curtice 1890)

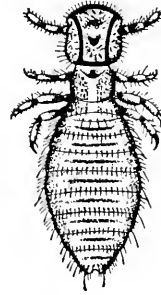

SHEEP LOUSE
Enlarged
(G. Neuman 1892)

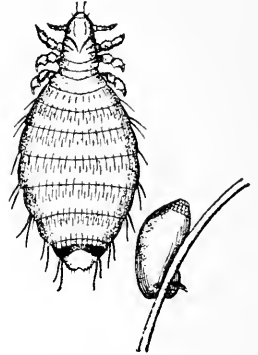

SHEEP FOOT LOUSE
Female and Egg
(Osborne 1896)

Attention should be paid to the feet and all flock owners should have a pair of hoof clippers. In wet seasons the toes grow rapidly and require frequent trimming. In addition a pot of Stockholm tar should be kept on hand. This can be used to great advantage on cuts, and smeared over the nostrils in cases of cold and during the fly season.

Any condition which causes the sheep to bite and scratch should be investigated at once and the cause definitely learned. Scab on certain parts of the sheep's body may be overlooked. It is usually found on the back or sides, but may start on any part of the body.

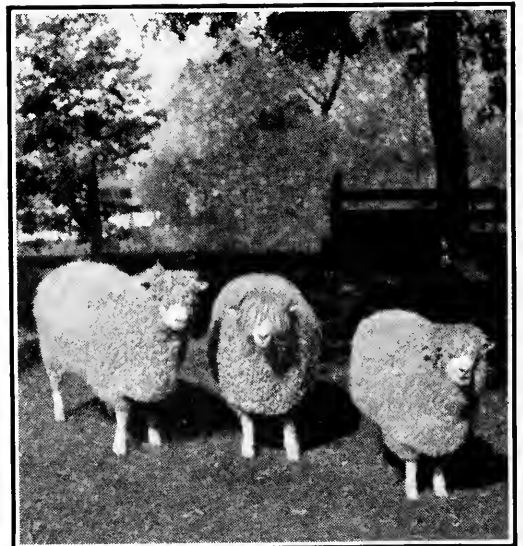

IMPORTED COTSWOLD EWES

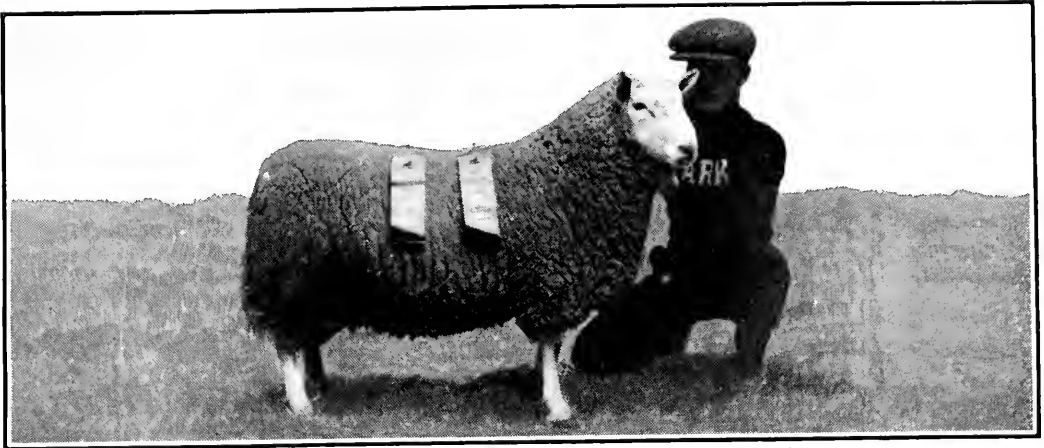

FIRST PRIZE CHEVIOT RAM—International Live Stock Exposition, Chicago, 1917.

Cheviots are native of Scotland, are small and hardy, but noted for excellent wool and mutton. Rams weigh up to 175 lbs., ewes 150 lbs., shearing 6 to 11 lbs. wool of medium length. Cheviots are splendid grazers and are profitable to handle.

LAMBING SEASON

Probably the success in sheep raising may be traced to the proper management during the lambing season.

From the time lambs are expected and until the season has ended, it is necessary that every care be given the ewes and lambs. The season is short, and it behooves the owner to be on the watch, otherwise his profits will be reduced through the death of the lambs, either from neglect or possibly during birth. Some ewes will refuse their lambs, others may not have sufficient nourishment for their young. Again we have ewes giving birth to triplets, one of which is perhaps weaker than its mates. If the weather is cold the lamb soon becomes chilled and it is necessary to be taken into some warm place.

The reader will appreciate that the flock will need constant watching. If triplets are born the weakest should be taken care of by hand and warm cow's milk given, and the same rule applies to the one whose dam has not sufficient nourishment. Where the mother disowns the lamb it must be held while nourishment is taken. Sometimes a little salt sprinkled on the wet lamb will induce the dam to accept it.

The owner should make it a point to see the young lambs suckle just as soon as they can stand, and to see it continues to do so. Orphan lambs, those raised by hand, should be taught to feed as soon as possible. They can be given very thinly sliced roots, with a little oatmeal sprinkled over them; later as they learn to eat, crushed grain and oil meal may be given.

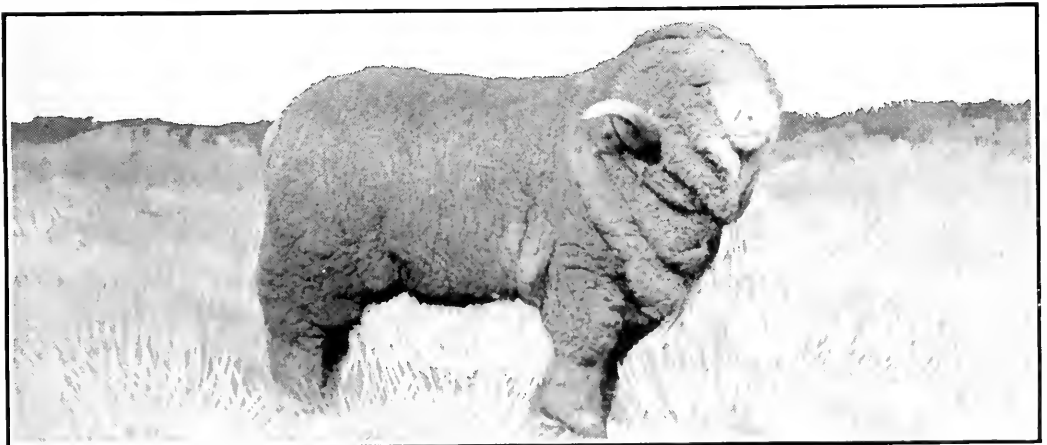

A CHAMPION MERINO RAM

The MERINO breed originating in America are of several families, chief of which are Delaines, which are divided into Nationals, Dickinsons, Black Tops and Standards. Rams weigh 130 to 200 lbs., ewes 100 to 140 lbs., shearing 8 to 20 lbs., according to type and weight. Merinos are known by three classes—Class A—heavy folds; Class B—smoother folds; Class C—smooth body with slight folds at neck, if at all. They are a fine wool type of sheep and very popular in the United States.



U. S. Government Publications

FREE

The United States Department of Agriculture, Washington, D. C., have available for free distribution the following list of publications which are especially recommended for the farmer or owner of live stock:

- | | |
|---------------------------------------|---|
| Tuberculosis, No. 473. | Equipment for Sheep Raising, No. 810. |
| Breeds of Swine, No. 765. | Breeds of Sheep for the Farm, No. 576. |
| Dehorning Cattle, No. 350. | Colts: Breaking and Training, No. 667. |
| Castration of Pigs, No. 780. | Farm Sheep Raising for Beginners, No. 840. |
| Neerotic Stomatitis, No. 67. | Cattle Lice and How to Eradicate Them, No. 909. |
| Swine Management, No. 874. | Ice House and the Use of Ice on the Dairy Farm, No. 623. |
| Breeds of Dairy Cattle, No. 893. | Utilization of Farm Wastes in Feeding Live Stock, No. 873. |
| Breeds of Draft Horses, No. 619. | Repellents for Protecting Animals From the Attack of Flies, No. 131. |
| Rabies or Hydrophobia, No. 449. | Influence of Age on the Value of Dairy Cows and Farm Horses, No. 451. |
| Production of Clean Milk, No. 602. | |
| Important Poultry Diseases, No. 530. | |
| The Control of Hog Cholera, No. 584. | |
| How to Select a Sound Horse, No. 779. | |

FOR SALE

at a few cents per copy, by the Superintendent of Documents, Government Printing Office, Washington, D. C. The following excellent publications are recommended to those interested in the subjects on which they treat:

- | | |
|--|--|
| Measles in Cattle, No. 214, price 10 cents. | Blackleg: Its Nature, Cause and Prevention, No. 31, price 5 cents. |
| Larkspur Poisoning of Live Stock, No. 365, price 25 cents. | The Granular Venereal Disease and Abortion in Cattle, No. 106. Price 10 cents. |
| Infectious Anaemia or Swamp Fever, No. 138. Price 5 cents. | |

392572

LIBRARY

ward

UNIVERSITY OF CALIFORNIA LIBRARY

CALENDAR FOR 1919

JANUARY							FEBRUARY							MARCH							APRIL						
S	M	T	W	T	F	S	S	M	T	W	T	F	S	S	M	T	W	T	F	S	S	M	T	W	T	F	S
..	1	2	3	4	1	1	1	2	3	4	5
5	6	7	8	9	10	11	2	3	4	5	6	7	8	2	3	4	5	6	7	8	6	7	8	9	10	11	12
12	13	14	15	16	17	18	9	10	11	12	13	14	15	9	10	11	12	13	14	15	13	14	15	16	17	18	19
19	20	21	22	23	24	25	16	17	18	19	20	21	22	16	17	18	19	20	21	22	20	21	22	23	24	25	26
26	27	28	29	30	31	..	23	24	25	26	27	28	..	23	24	25	26	27	28	29	27	28	29	30
..	30	31

MAY							JUNE							JULY							AUGUST						
S	M	T	W	T	F	S	S	M	T	W	T	F	S	S	M	T	W	T	F	S	S	M	T	W	T	F	S
..	1	2	3	1	2	3	4	5	6	7	1	2	3	4	5	1	2
4	5	6	7	8	9	10	8	9	10	11	12	13	14	6	7	8	9	10	11	12	3	4	5	6	7	8	9
11	12	13	14	15	16	17	15	16	17	18	19	20	21	13	14	15	16	17	18	19	10	11	12	13	14	15	16
18	19	20	21	22	23	24	22	23	24	25	26	27	28	20	21	22	23	24	25	26	17	18	19	20	21	22	23
25	26	27	28	29	30	31	29	30	27	28	29	30	31	24	25	26	27	28	29	30
..	31

SEPTEMBER							OCTOBER							NOVEMBER							DECEMBER						
S	M	T	W	T	F	S	S	M	T	W	T	F	S	S	M	T	W	T	F	S	S	M	T	W	T	F	S
..	1	2	3	4	5	6	1	2	3	4	1	..	1	2	3	4	5	6
7	8	9	10	11	12	13	5	6	7	8	9	10	11	2	3	4	5	6	7	8	7	8	9	10	11	12	13
14	15	16	17	18	19	20	12	13	14	15	16	17	18	9	10	11	12	13	14	15	14	15	16	17	18	19	20
21	22	23	24	25	26	27	19	20	21	22	23	24	25	16	17	18	19	20	21	22	21	22	23	24	25	26	27
28	29	30	26	27	28	29	30	31	..	23	24	25	26	27	28	29	28	29	30	31
..	30

CALENDAR FOR 1920

JANUARY							FEBRUARY							MARCH							APRIL						
S	M	T	W	T	F	S	S	M	T	W	T	F	S	S	M	T	W	T	F	S	S	M	T	W	T	F	S
..	1	2	3	1	2	3	4	5	6	7	..	1	2	3	4	5	6	1	2	3
4	5	6	7	8	9	10	8	9	10	11	12	13	14	7	8	9	10	11	12	13	4	5	6	7	8	9	10
11	12	13	14	15	16	17	15	16	17	18	19	20	21	14	15	16	17	18	19	20	11	12	13	14	15	16	17
18	19	20	21	22	23	24	22	23	24	25	26	27	28	21	22	23	24	25	26	27	18	19	20	21	22	23	24
25	26	27	28	29	30	31	29	28	29	30	31	25	26	27	28	29	30	..
..

MAY							JUNE							JULY							AUGUST						
S	M	T	W	T	F	S	S	M	T	W	T	F	S	S	M	T	W	T	F	S	S	M	T	W	T	F	S
..	1	1	2	3	4	5	1	2	3	1	2	3	4	5	6	7
2	3	4	5	6	7	8	6	7	8	9	10	11	12	4	5	6	7	8	9	10	8	9	10	11	12	13	14
9	10	11	12	13	14	15	13	14	15	16	17	18	19	11	12	13	14	15	16	17	15	16	17	18	19	20	21
16	17	18	19	20	21	22	20	21	22	23	24	25	26	18	19	20	21	22	23	24	22	23	24	25	26	27	28
23	24	25	26	27	28	29	27	28	29	30	25	26	27	28	29	30	31	29	30	31
30	31

SEPTEMBER							OCTOBER							NOVEMBER							DECEMBER						
S	M	T	W	T	F	S	S	M	T	W	T	F	S	S	M	T	W	T	F	S	S	M	T	W	T	F	S
..	1	2	3	4	1	2	..	1	2	3	4	5	6	1	2	3	4	
5	6	7	8	9	10	11	3	4	5	6	7	8	9	7	8	9	10	11	12	13	5	6	7	8	9	10	11
12	13	14	15	16	17	18	10	11	12	13	14	15	16	14	15	16	17	18	19	20	12	13	14	15	16	17	18
19	20	21	22	23	24	25	17	18	19	20	21	22	23	21	22	23	24	25	26	27	19	20	21	22	23	24	25
26	27	28	29	30	24	25	26	27	28	29	30	28	29	30	26	27	28	29	30	31	..
..	31